

GMC INSTRUMENTS

 **GOSSEN METRAWATT**

 **CAMILLE BAUER**

 **DRANETZ**

SECURING THE ELECTRICAL ENERGY SUPPLY

SOLUTIONS BY POWER QUALITY
MONITORING



ENERGY IS SECURITY - WE SECURE ENERGY



ENERGY IS LIFE

Life without electric power is unimaginable today. Infrastructures like functioning water supply, efficient traffic carriers and routes as well as information and telecommunication technology are available and usable at any time plus functioning administration and health care services are considered the life blood of modern, highly technologised societies.

Supply security of the energy grid

The supply security of the electrical power grid forms the basis of our infrastructure and thus of our safety and our wellbeing.

Infrastructure of our modern society

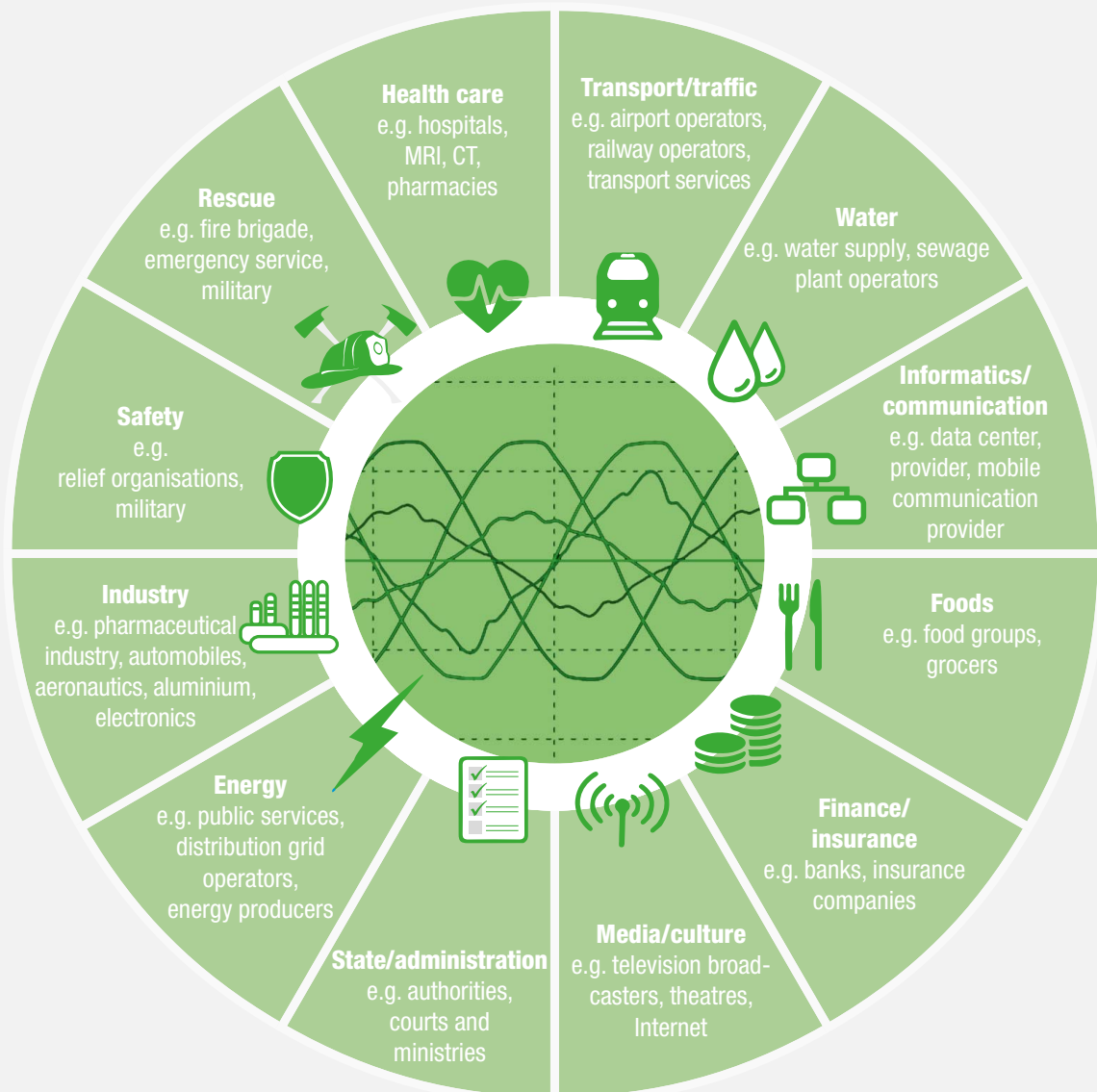

GRIDS ARE CHANGING

Modern power electronics or non-linear consumers increasingly impair electrical grids which is the reason why, already for a long time, alternating current has not shown the original sinusoidal characteristic as we still know it from ohmic consumers like light bulbs or directly operated asynchronous motors.

This strains electrical devices and machines and causes considerably increased heat losses, rising energy consumption and also the disturbance and failure of plants.

In addition, there is the change from central power generation with an easily predictable, unidirectional power flow in the distribution grid to a volatile power grid supplemented by alternative energy producers with a

multidirectional flow. The power is not generated by dynamo-electrical generators any more, but is increasingly derived from DC power sources which are taken to an approximately sinusoidal consumer via DC/AC converters.

Grid disturbance level

- Strong increase in non-linear consumers (LED lighting, computers, charging equipment, consumers etc.) generating harmonics
- Increase of decentralized feed (e.g. wind power, PV plants) causing voltage instability

POWER SUPPLY AND CONSUMERS CHANGING OVER TIME

Conventional central supply

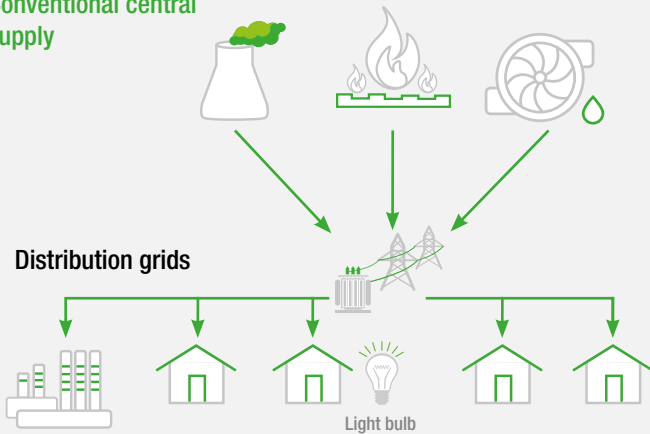

Today

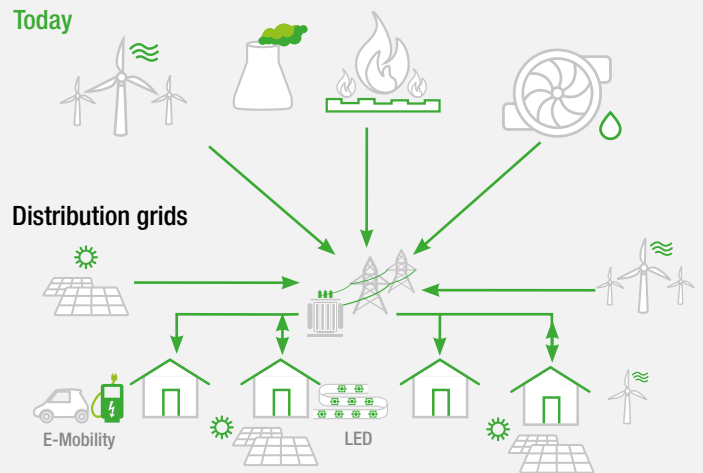

Principle of system perturbation

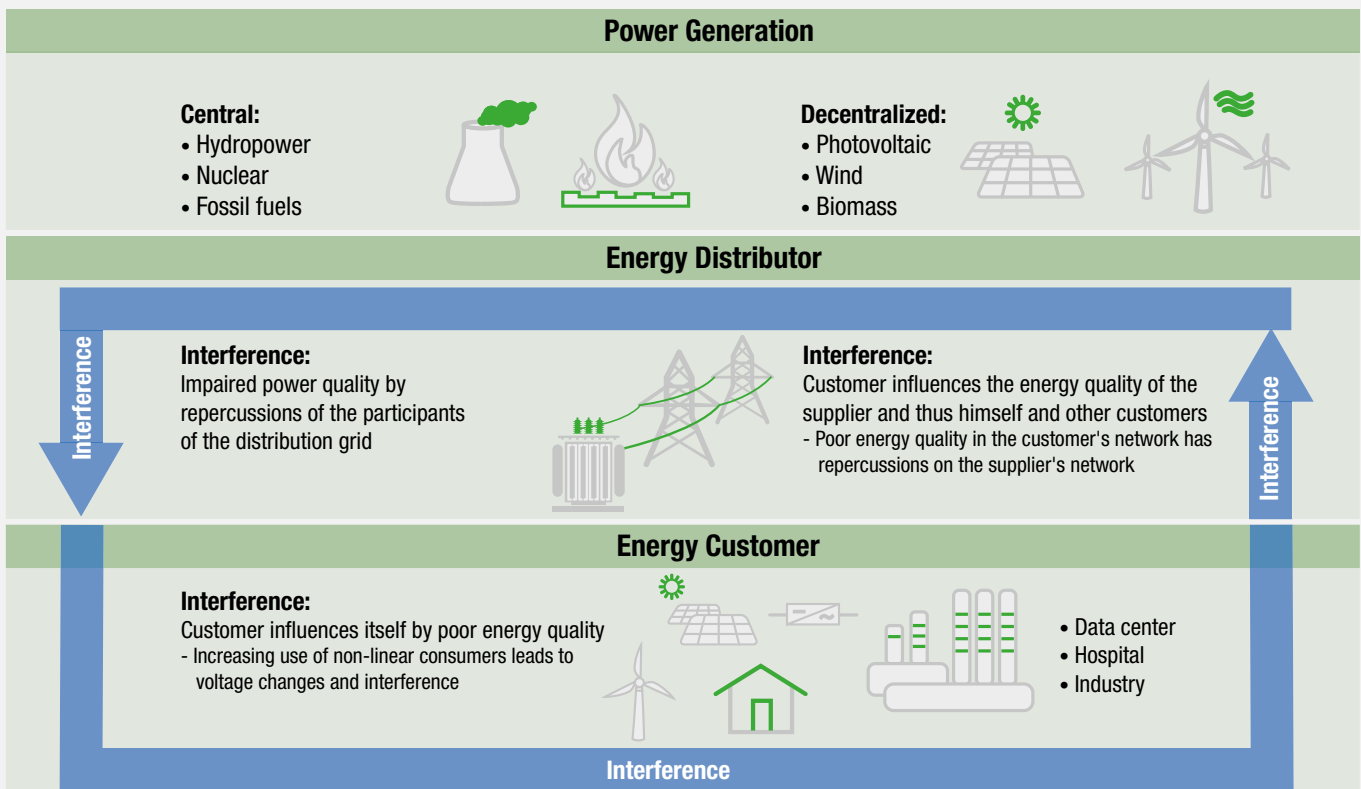



GRID PHENOMENA

We encounter grid phenomena daily

Even if we have a very dependable supply of electrical energy at first glance, we encounter daily phenomena in the electrical grid which individually or in total may become serious problems for people, machines and the environment. A survey from 2007 already stated the economic loss by grid phenomena to be 157 billion Euro / year, with a substantially growing tendency.

Power quality is not a new topic, although in recent years, due to an increasingly technologically advanced and vulnerable world, it has become more and more of a focus.

The consideration and the limits for the electrical phenomena derive from the standardization for the electromagnetic compatibility of the IEC 61000-x-x.

VOLTAGE PHENOMENA	CAUSES	POSSIBLE SUBSEQUENT PROBLEMS
<p>Grid frequency</p>	<ul style="list-style-type: none"> Loss of power generators Big load changes 	<ul style="list-style-type: none"> Instability of the supply grid
<p>Level of supply voltage</p>	<ul style="list-style-type: none"> Change in grid load 	<ul style="list-style-type: none"> Disturbance of equipment Plant shutdown Data loss
<p>Flicker</p>	<ul style="list-style-type: none"> Frequent load changes Motor start 	<ul style="list-style-type: none"> Lighting flickering Impairment of the work performance of exposed persons
<p>Dips / excesses of supply voltage. Rapid voltage changes (RVC) (often referred to as a transient)</p>	<ul style="list-style-type: none"> Big load changes Short circuits, earth connections Thunderstorms Overload of energy supply Feed-in of renewable energies, like by wind or photovoltaics 	<ul style="list-style-type: none"> Disturbance of equipment like controls or drives Breakdown Data loss of controls and computers
<p>Voltage interruptions</p>	<ul style="list-style-type: none"> Short circuits Triggered fuses Component breakdown Planned interruption of supply 	<ul style="list-style-type: none"> Loss of production Process interruptions Data loss of controls and computers
<p>Imbalance of supply voltage</p>	<ul style="list-style-type: none"> Uneven load of phases due to single or two-phase consumers 	<ul style="list-style-type: none"> Current in the neutral conductor Overload / overheating of equipment Increase of harmonics
<p>Harmonic voltages</p>	<ul style="list-style-type: none"> Non-linear loads like frequency converters, rectifiers, switching power supplies, arc furnaces, computers, fluorescent tubes, etc. 	<ul style="list-style-type: none"> Reduction of machine efficiency Increased energy losses Overload / overheating of equipment Current in the neutral conductor
<p>Interharmonic voltages, voltages for signal transmission</p>	<ul style="list-style-type: none"> Frequency converters and similar control devices 	<ul style="list-style-type: none"> Flicker Disturbance of ripple control
<p>Transients Fast changes in a wave form low frequency/high frequency</p>	<ul style="list-style-type: none"> Lightning strike Switching operations 	<ul style="list-style-type: none"> Destruction of equipment Data loss Plant shutdown

AREAS OF APPLICATION OF POWER QUALITY MONITORING

IEC 61000-2-12

EMC compatibility level for medium voltage

IEC 61000-2-2

EMC compatibility level for low voltage

IEC 61000-2-4

EMC compatibility level for industry and non-public grids

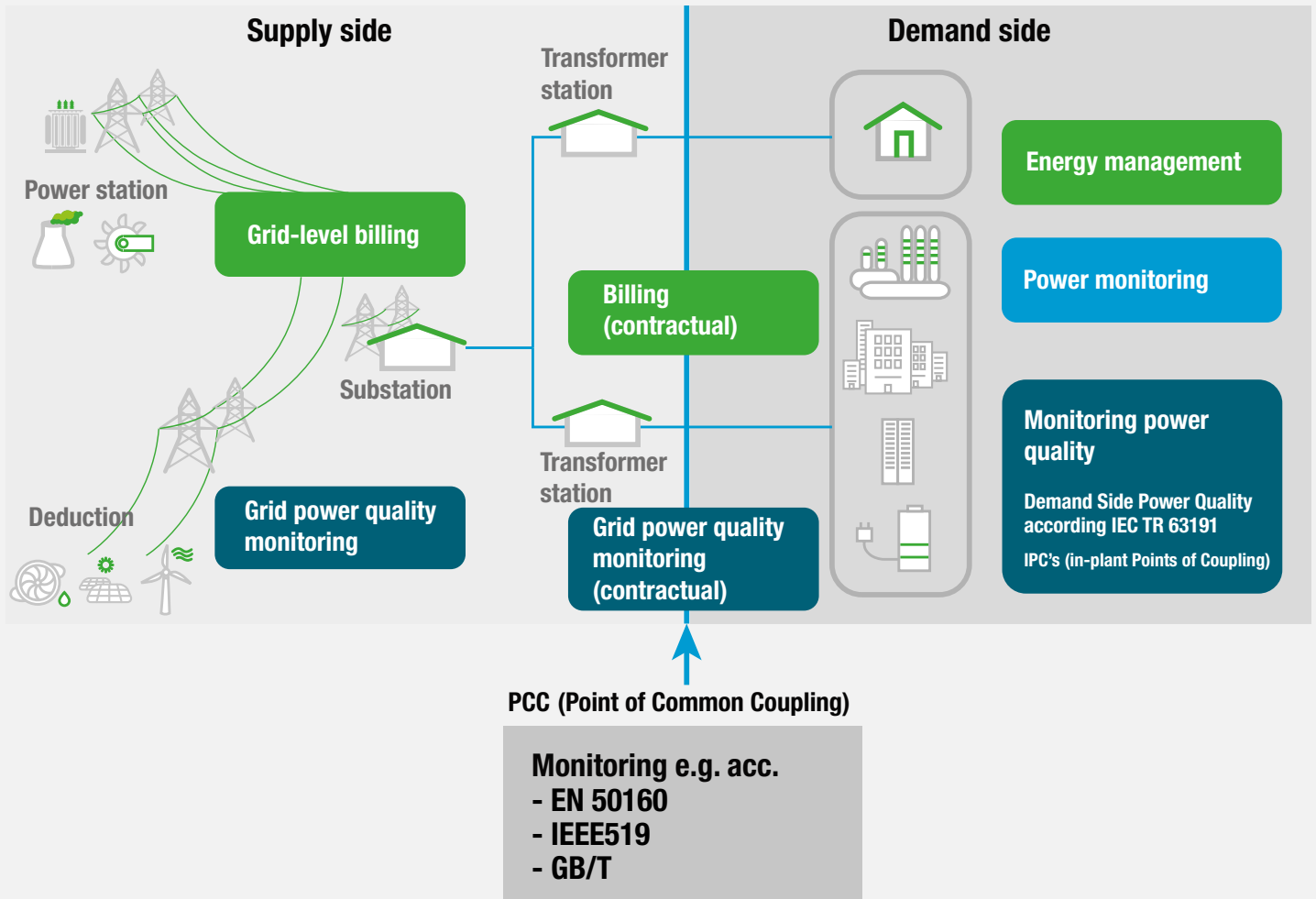

Normative power quality monitoring at the PCC

The common standards determine the voltage quality at the transfer point (PCC) of the utility to the grid user.

The measurement at the PCC is used to check and comply with standards (e.g. EN 50160) and contracts between energy provider and energy consumers.

Due to the continuous monitoring, a deterioration of the power quality can be detected early on and causes can be sought. The effectiveness of measures taken can be checked directly.

Power quality measurement in the field or in the application (DSPQ - Demand Side Power Quality)

The IEC TR 63191 technical report DSPQ describes the phases that are necessary for the creation of a consumer-side power quality measurement plan for buildings and industrial facilities.

Such a power quality measurement plan enables the optimization of energy availability and efficiency and improves the lifetime of plants. If power quality phenomena are already present, it facilitates the diagnosis and correction of these quality problems.

More details see page 11.



MEASURING, RECORDING AND EVALUATING POWER QUALITY

TEST AND MEASURING PROCEDURE – IEC 61000-4-X

• **IEC 61000-4-30 Ed. 3**

Power quality measuring procedure.

Acc. to chapter 5.9.1 „Measurement method“:

Measurement up to the 50th harmonic (bandwidth of 2.5 kHz at 50 Hz, requires a minimum sampling rate of 5 kHz).

New items of IEC 61000-4-30 Ed. 3 as compared to IEC 61000-4-30 Ed. 2

- + Current measurement is obligatory for **Class A** devices
- + Recording of level, imbalance, harmonics and interharmonics of currents in the same interval as the pertaining voltage channels
- + Measuring procedure for rapid voltage changes (RVC) has been added

CLASS A

Measuring instruments according to IEC 61000-4-30 **Class A** provide measured values comparable across measuring instruments and manufacturers. Measured values of **Class S** measuring instruments cannot be considered comparable anymore.

- **IEC 61000-4-7**
Guideline to measure harmonics / interharmonics
- **IEC 61000-4-15**
Flicker meter design specifications

IMPORTANT!

The conformity of the test and measuring procedure of a measuring instrument according to IEC 61000-4-x is checked on basis of IEC 62586-2!

ADVANTAGES OF METROLOGICAL CERTIFICATION FOR STANDARDS-COMPLIANT MEASURING DEVICES

Despite the fact that the demands on a power quality device have been exactly defined both in terms of measuring procedures (IEC 61000- 4-30), device properties (IEC 62586-1) and test and compliance with standards (IEC 62586-2), there are, nevertheless, differences between manufacturers. In particular, providers can often not prove why their analysis device

meets the specifications, i.e. measures correctly. The proof of a really correct measurement can only be provided by an independent certification authority, optimally a metrological institute. Test organisations which are not certified or even manufacturers' own declaration cannot replace metrological certificates and should, therefore, be considered with caution.

Examples (association):



Calibration **and** tracing to the SI unit is the only way to ensure that 1 kg is really 1 kg and indicated as such.

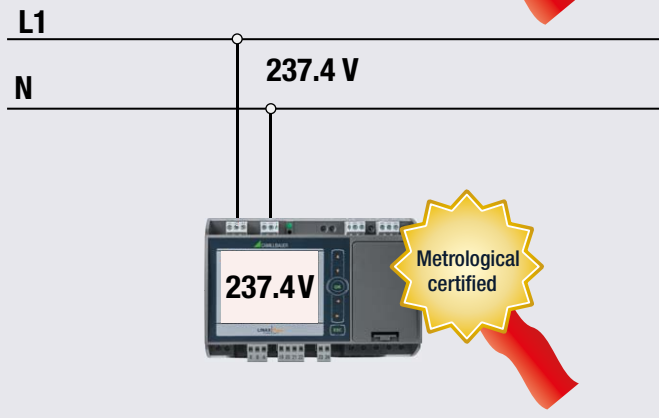

The LINAX PQ3000 power quality measuring instrument shows 237.4 V. The independent metrological certification provides the assurance that exactly 237.4 V exist. The certification of a power quality measuring instrument according to IEC 62586-2 requires more than 150 partly extensive tests. An involved test infrastructure traced back by calibration to the International System of Units SI is required for this purpose.



* METAS (Confederate Institute for Metrology) has extended its measuring and test infrastructure for Phasor Measurement Units (PMUs) to power quality variables and can now, being one of only a few laboratories world-wide, calibrate, test and certify PMUs according to IEEE C37.118 and power quality measuring instruments according to IEC 62586. The PMU measuring station permits the UTC-synchronised generation of voltage and current signals and is traced back to the International System of Units SI by calibration.



RECORDING AND EVALUATION OF THE MEASURED DATA

Energy supply disturbance can lead to production and equipment failure. Frequently, the reaction only comes after a high financial loss has occurred. But many of these incidents could be avoided, if the signs had been recognized in time by continuous monitoring of the situation.

Power quality monitoring provides both a statistical evaluation permitting a comparison with standards (e.g. EN 50160) or supply contracts and recording of grid events (e.g. voltage drops) to enable the analysis of their causes and consequences.

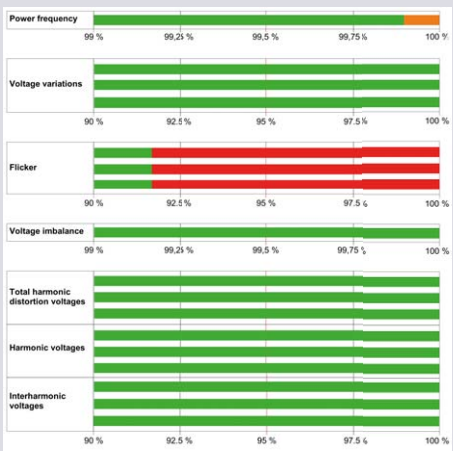
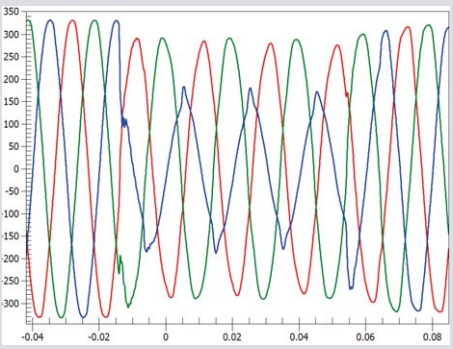
POWER QUALITY EVALUATION	DESCRIPTION	BENEFIT
<p>Statistical evaluation</p> 	<p>All of the relevant supply voltage parameters are monitored, statistically averaged and compared with specified values. In this way, conformity can be proven or attention can be drawn to possible problems.</p> <p>Currents are also monitored in relation to level, harmonic content and imbalance. However, these results do not form an integral part of the statistical evaluation since limit values are not available.</p>	<p>Verification of the adherence to standards (e.g. EN 50160) or contracts between energy supplier and energy consumer.</p> <p>Observing the change of results makes it possible to determine a deterioration of the power quality and the search of its causes in good time. The effectiveness of introduced measures can be directly verified.</p>
<p>Event recording</p> 	<p>All voltages are monitored for disturbances, such as dip, interruption or swell. These incidents are registered as event. A statistical evaluation is not required because there is no limitation for such events.</p> <p>For a configurable period of time, any event recording contains for all voltages and currents:</p> <ul style="list-style-type: none"> • The curve shape • The progression of RMS half-cycle values 	<p>The evaluation of a disturbance recording enables the discovery of the cause and, in the best case, a correlation with the determined events can be established (e.g. breakdown of control or equipment). Appropriate remedy measures can be derived from this and verified in respect of their effectiveness.</p>

Power quality evaluation

PQ data



Voltage events

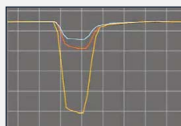

1/2 periods RMS

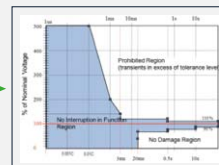

Classification according to the ITIC curve

Statistical evaluation

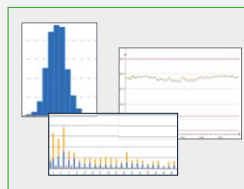

10/12 periods RMS



1 week

Evaluation according to

- EN 50160
- IEC 61000-2-2 (LV)
- IEC 61000-2-4 (industry)
- IEC 61000-2-12 (MV)
- + further items in progress



RELEVANT STANDARDS WHEN CONSIDERING THE POWER QUALITY

Power quality is not a new issue, although in recent years, due to an increasingly technologically advanced and vulnerable world, it has become more and more of a focus.

The consideration and the limits of electrical phenomena are derived from the standardization of electromagnetic compatibility (EMC) of IEC 61000-x-x.

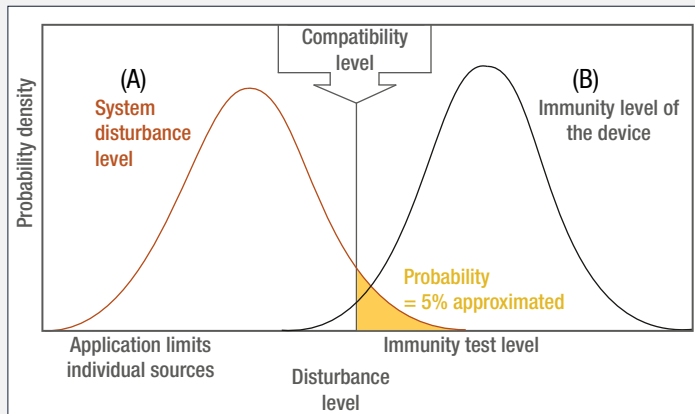

Figure 1 (source: EN 61000-2-2, Appendix A)
Principle of electromagnetic compatibility. Consideration of limits for the emission of disturbances and immunity

Emission = emitted disturbance (A)

Immission = disturbance compatibility (B)

Since it is impossible either to prevent all disturbances of the power quality or to make all devices completely stable to these disturbances, limits for the emission of disturbances and for the stability are agreed.

This is a principle established in the field of electromagnetic compatibility, which takes into account aspects of technical feasibility and cost-effectiveness.

Evaluation of the quality of an electrical grid

- **IEC 61000-2-2**
Environment - compatibility levels for low-frequency conducted disturbances and signalling in public low-voltage power supply systems (measurement at the PCC - Point of Common Coupling)
- **IEC 61000-2-4**
Environment - compatibility levels for low-frequency conducted disturbances in industrial plants (for industrial and non-public 50 / 60 Hz LV and MV alternating current systems up to 35 kV)
3 environment classes (measurement at the PCC, internal connection points)
- **IEC 61000-2-12**
Environment - compatibility levels for low-frequency conducted disturbances and signalling in public medium-voltage power supply systems (measurement at the PCC)

Voltage characteristics in public power supply systems

- **EN 50160**
Voltage characteristics in public LV, MV and HV power supply systems (measurement at the PCC)

EVERYTHING IS OK - THE PLANT BREAKS DOWN

The industrial park has just been completed. All of the facilities and systems are modern and state-of-the-art. In planning and implementation, strict attention was paid to the fact that all devices and machines complied with EMC guidelines in relation to emission and immission. In addition, a statistical evaluation of the electrical grid parameters of the EN 50160 standard confirms that all parameters stay in their specified ranges (example figure 2). Comprehensive energy monitoring acquires all of the consumption data.

The whole plant is working in an optimum fashion, energy efficient and breaks down twice a week.

This phenomenon is no isolated occurrence. Operators mostly face an enigma. Despite careful planning and compliance with all provisions, serious disturbances occur which cannot be identified by any of the measuring equipment used.

The reason is to be found in the complexity of today's facilities. The addition of disturbance levels leads, in the worst case, to an impairment of the plant (see figure 1, page 8). As grid phenomena occur only occasionally, they do not affect the statistical overall evaluation which, in total, leads to a wrong assessment of plant reliability.

At this point, potential problems can be quickly identified by targeted measurements and corresponding activities initiated.

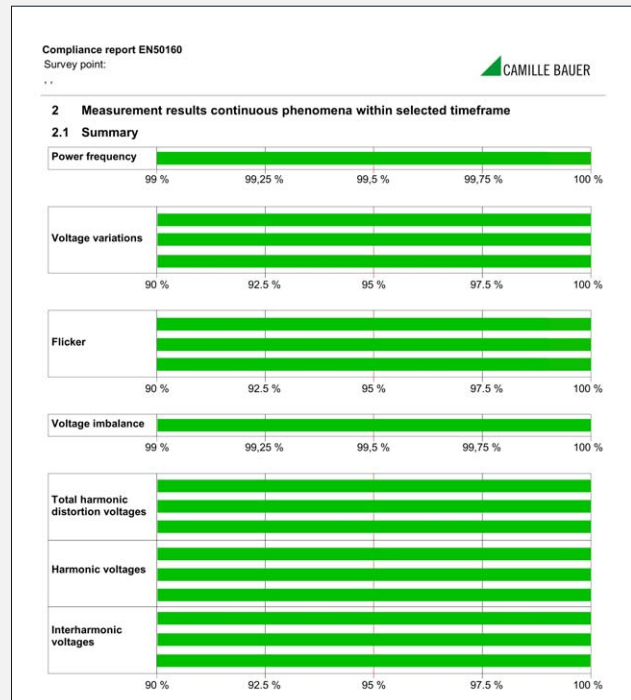

Figure 2

Such statistical power quality evaluations prove required conformities or identify possible problems. However, one has to be careful. Such statistically averaged evaluations do not state that there were not any events during the respective period of time.

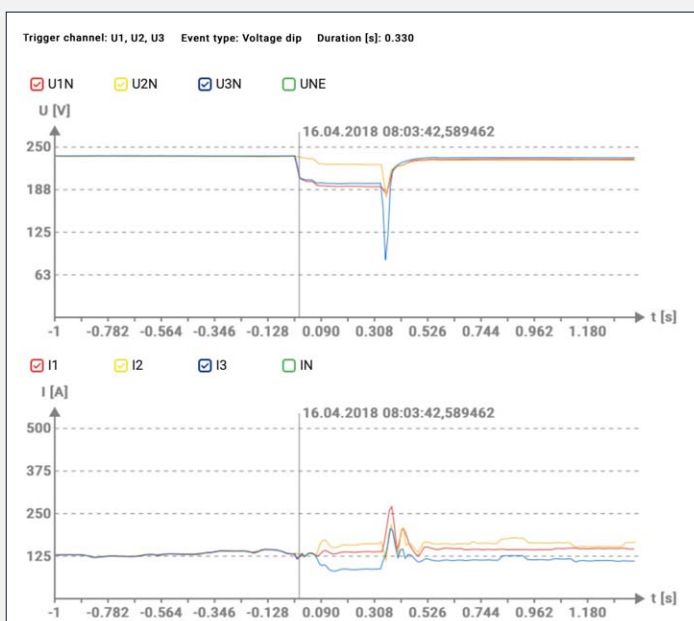

Figure 3

Voltage dips



Everything is statistically OK
CAUTION: problems are nevertheless possible!

A glance at the definition of EN 50160 immediately shows that even voltage dips as depicted in figure 3, which would surely lead to a breakdown of the machine or plant, do not appear in the statistical consideration (since only 10-minutes of average values are considered) and thus remain "invisible" in a purely statistical evaluation.

Excerpt from EN 50160

- At least 95 % (LV) or 99 % (MV) of all 10-minute average values of the supply voltage effective value must range within the limits stated
- No 10-minute average value of the supply voltage effective value may range outside of the limit of +10 %/ -15 % U_n (LV) or ± 15 % U_c (MV)



POWER QUALITY AND INDUSTRIAL ENERGY & DATAMANAGEMENT

SUPPLY AND SERVICES

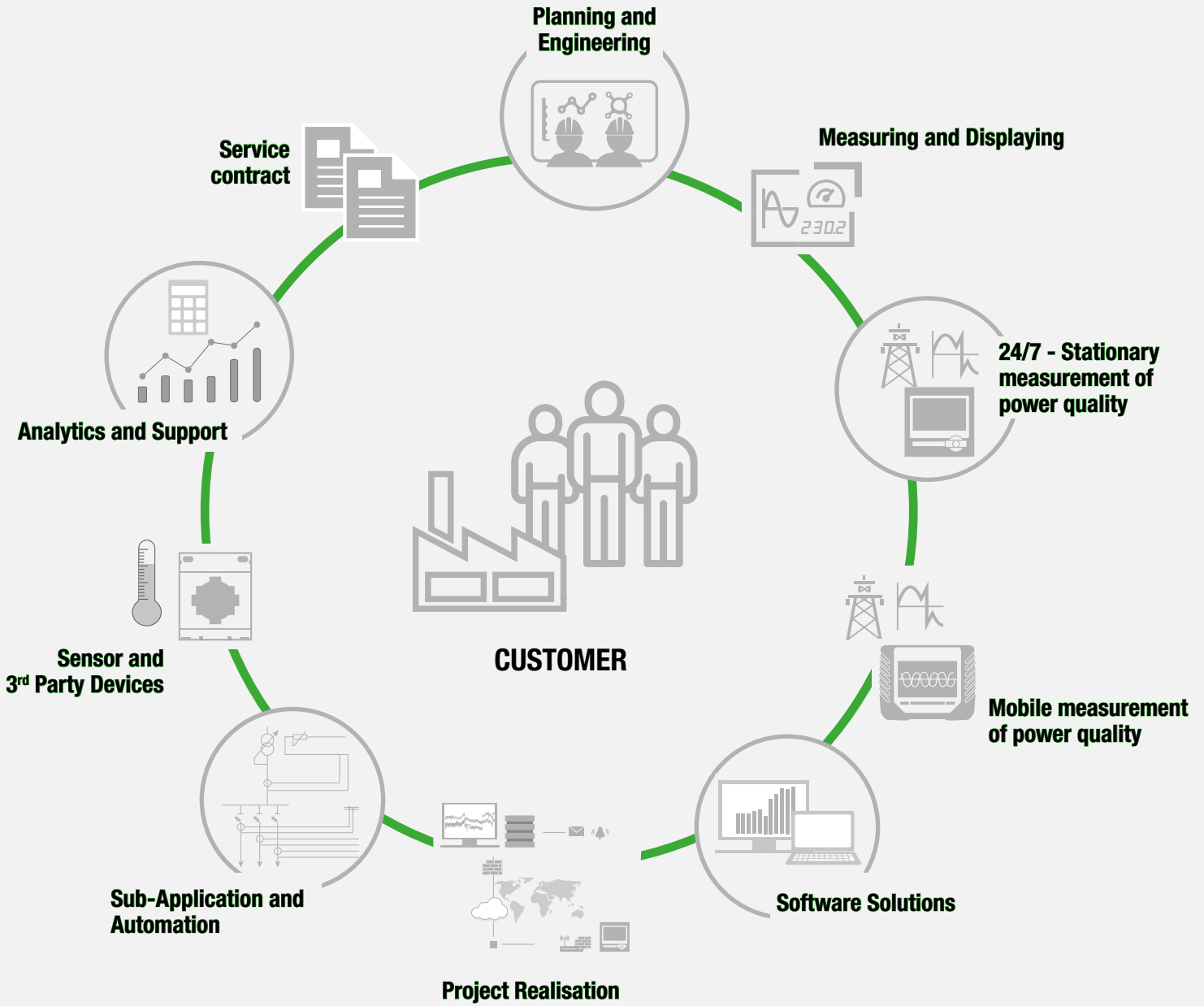

We design modular customer-specific solutions and systems which can be extended at any time regardless of manufacturer. Through our non-proprietary interfaces is also an integration in already existing applications and systems with components from different manufacturers no problem.

RECOGNISING PROBLEMS BEFORE THEY OCCUR

MONITORING THE POWER QUALITY ON THE DEMAND SIDE

- Demand Side Power Quality according IEC TR 63191
- IPC's (in-plant Points of Coupling)



About 80 % of all PQ disturbances are originating inside the facilities after the PCC (Point of Common Coupling) and not by external sources.



24/7 - STATIONARY MEASUREMENT OF POWER QUALITY

Measurement of all electrical variables incl. event recording and disturbance recorder function



SINEAX AM SERIES (AC)

Compact devices for measurement and monitoring in the power system

- Harmonic analysis according to IEC 61000-4-7
- 1500 items of information concerning energy consumption, grid condition and power quality
- Panel installation 96 x 96 mm and 144 x 144 mm
- Disturbance recorder: Voltage events acc. IEC 61000-4-30



SINEAX DM5000 (AC)

Compact device to monitor all aspects of power distribution

- Harmonic analysis according to IEC 61000-4-7
- Grid condition monitoring: Class 0.1 (U/I), Class 0.2 (P/Q/S)
- Top hat rail device
- Disturbance recorder: Voltage events acc. IEC 61000-4-30

Measuring instruments for power quality monitoring, metrologically certified



LINAX PQ1000 (AC)

The system for power system analysis

- Power quality analysis in class S according to IEC 61000-4-30
- Conformity assessment in distribution networks and IPCs according to common standards and own limit values
- Design variants (top hat rail mounting with/without display, panel mounting 96 x 96 mm)



LINAX PQ3000/PQ5000 (AC)

Compact devices for power quality monitoring in electrical grids

- Certified power quality analysis in Class A, according to IEC 61000-4-30 Ed. 3
- Data exchange for power quality data: PQDIF
- PQ conformity reports via website possible without any external software



LINAX PQ5000-RACK (AC)

Power quality monitoring in the electrical system in a 19" rack according to EN 60297

- Certified power quality analysis in Class A, according to IEC 61000-4-30 Ed. 3
- Analyzing of two power systems (e. g. double busbar, transformer)
- Optional data transmission via cellular network and synchronization via GPS
- Current measurement via current transformer (1/5 A) or small signal sensors (<3V)



MOBILE MEASUREMENT OF POWER QUALITY

Mobile devices



MAVOWATT 230 (AC/DC)

Three-phase energy and grid disturbance analysers

- Power quality analysis in Class A according to IEC 61000-4-30 Ed. 3
- Transient acquisition from 32 / 40 μ s (50 / 60 Hz)
- Acquisition harmonics and interharmonics U (127), I (63)



MAVOWATT 240 (AC/DC)

All Mavowatt 230 capabilities, plus:

- WiFi communication
- Answer Modules for automatic power quality event directivity reporting
- 10 000 cycle pre / post cycle recording



MAVOWATT 270 (AC/DC)

All Mavowatt 240 capabilities, plus:

- High speed transient acquisition from 1 μ s
- Advanced Energy Monitoring according to IEEE 1459



MAVOWATT 270-400 (AC/DC)

All Mavowatt 240 capabilities, plus:

- High speed transient acquisition from 1 μ s
- Advanced Energy Monitoring according to IEEE 1459
- 400 Hz monitoring



MAVOWATT 30 (AC/DC)

8-channel grid disturbance analyser

- Power quality analysis in Class A according to IEC 61000-4-30 Ed. 2
- Transient acquisition from 80 μ s
- Lightweight with only approx. 1.9 kg



DRANXPERT

Portable energy/power logger & PQ detector

- 3-phase, bi-directional power/energy logger
- Detection and recording of common PQ problems
- Web browser interface & free software for analysis and reporting
- 7h battery runtime



HDPQ VISA / GUIDE / XPLORER / XPLORER 400 SP (AC/DC)

Contains all features of the corresponding Mavowatt 2xxx series devices, however:

- No display, operation via tablet / PC / smartphone
- Power from the phase
- Protection class IP65

Mobile device, metrologically certified



LINAX PQ5000 MOBILE (AC)

Mobile device to monitor power quality in electrical grids

- Power quality analysis in Class A, according to IEC 61000-4-30 Ed. 3 (metrologically certified)
- PQ conformity report via website
- User LAN / WLAN interface via PC, laptop, tablet and smartphone



24/7 - OVERVIEW DEVICES STATIONARY MEASUREMENT



PQ-Device differentiation	SINEAX AM Series	SINEAX DM5000	LINAX PQ1000	LINAX PQ3000/PQ5000
Design	96x96 / 144x144	DIN TOP-HAT RAIL	DIN rail / 96x96	DIN rail/144x144/rack 19"
Display/operation	✓ / Buttons	✓ / Buttons	✓ / Buttons	✓ / Buttons
Measuring				
IEC 61000-4-30	–	–	Class S / Ed. 3	Class A / Ed. 3
Sampling rate (bandwidth)	18 kHz (4.5 kHz)	18 kHz (4.5 kHz)	18 kHz (4.5 kHz)	18 kHz (4.5 kHz)
Samples per period 50 / 60 Hz	360 / 300	360 / 300	360 / 300	360 / 300
Transientrecord	Waveform	Waveform	Waveform	Waveform
RCM	✓	✓	✓	✓
Energy meter	✓	✓	✓	✓
Conformity standards	–	–	EN 50160 IEC 61000-2-2 IEC 61000-2-4 IEC 61000-2-12 IEEE 519 GB/T	EN 50160 IEC 61000-2-2 IEC 61000-2-4 IEC 61000-2-12 IEEE 519 GB/T
Accuracy U / I [%]	0.1 / 0.1	0.1 / 0.1	0.2	0.1
Accuracy energy meter	0.2S / 0.5S	0.2S	0.5S	0.2S
Voltage measurement				
Overvoltage category	600 V CAT III	600 V CAT III	600 V CAT III	600 V CAT III
Number of channels	4	4	3	4
Measuring range LN / LL	480 V / 832 V	480 V / 832 V	480 V / 832 V	480 V / 832 V
Power frequency	42 ... 69.5 Hz	42 ... 69.5 Hz	42 ... 69.5 Hz	42 ... 69.5 Hz
Current measurement				
Sensor technology	CT	CT	CT	CT
Category	300 V CAT III	300 V CAT III	300 V CAT III	300 V CAT III
Number of channels	4	4	3	4
Measuring range (device) In / I _{max}	5 A / 7.5 A	5 A / 7.5 A	5 A / 7.5 A	5 A / 7.5 A
Recording/protocol				
Memory size	16GB	16GB	16GB	16GB
PQDIF	–	–	via browser / SFTP	via browser / SFTP
CSV	via browser	via browser	via browser / SFTP	via browser / SFTP
PDF conformity report	–	–	via browser / software	via browser / software
Power supply				
Supply	100 ... 230 V AC/DC 24/48 V DC	100 ... 230 V AC/DC 24/48 V DC	100 ... 230 V AC/DC 24/48 V DC	100 ... 230 V AC/DC 24/48 V DC
Battery power reserve or UPS	5 x 3 min	5 x 3 min	–	5 x 3 min
Supply from voltage measurement	–	–	–	–
Communication				
Interface	Ethernet RS485	Ethernet RS485	Ethernet RS485	Ethernet RS485
Protocol	Modbus Profinet IEC 61850	Modbus Profinet IEC 61850	Modbus Profinet IEC 61850	Modbus Profinet IEC 61850

FAULT FINDING - OVERVIEW MOBILE DEVICES



MAVOWATT 230	MAVOWATT 240	MAVOWATT 270	MAVOWATT 270-400	MAVOWATT 30	DRANXPRT	HDPQ Guide SP	LINAX PQ5000 MOBILE
Handheld	Handheld	Handheld	Handheld	Handheld	Handheld	IP65	Handheld
✓ / Touch	✓ / Touch	✓ / Touch	✓ / Touch	✓ / Touch	- / WebGui	- / remote tablet	- / WebGui
Class A / Ed. 3	Class A / Ed. 3	Class A / Ed. 3	Class A / Ed. 3	Class A / Ed. 2	-	Class A / Ed. 3	Class A / Ed. 3
25.6 kHz (7 kHz)	25.6 kHz (7 kHz)	25.6 kHz (7 kHz)	25.6 kHz (9 kHz)	12.8 kHz	32 ksps	25.6 kHz (7 kHz)	18 kHz (4.5 kHz)
512 / 427	512 / 427	512 / 427	512 / 427 (400 Hz: 32)	256 / 213	128	512 / 427	360 / 300
>32µs	>32µs	>1µs	>1µs	>80µs	-	>32µs	-
-	-	-	-	-	-	-	-
✓	✓	✓	✓	✓	✓	✓	✓
EN 50160 IEEE 519	EN 50160 IEEE 519	EN 50160 IEEE 519	EN 50160 IEEE 519	EN 50160 IEEE 519	-	EN 50160 IEEE 519	EN 50160 IEC 61000-2-2 IEC 61000-2-4 IEC 61000-2-12 IEEE 519.3 GB/T
0.1±0.05FS	0.1±0.05FS	0.1±0.05FS	0.1±0.05FS	0.1±0.05FS	±0.1% + Sensor	0.1±0.05FS	0.1
0.2S	0.2S	0.2S	0.2S	-	0.1 %	0.2S	0.2S
1000 V CAT III	1000 V CAT III	1000 V CAT III	1000 V CAT III	600 V CAT III	600 Vrms CATIII	1000 V CAT III	600 V CAT III
4	4	4	4	4	3	4	4
600 V / 1000 V	600 V / 1000 V	600 V / 1000 V	600 V / 1000 V	600 V / 1000 V	600 V	600 V / 1000 V	480 V / 832 V
16 ... 25 Hz 42.5 ... 65 Hz	16 ... 25 Hz 42.5 ... 65 Hz	16 ... 25 Hz 42.5 ... 65 Hz	42.5 ... 65 Hz 380 ... 420 Hz	15 ... 20 Hz 40 ... 3000 Hz	45 Hz ... 55 Hz 55 Hz ... 65 Hz	16 ... 25 Hz 42.5 ... 65 Hz	50 Hz / 60 Hz
Rogowski/clip	Rogowski/clip	Rogowski/clip	Rogowski/clip	Rogowski/clip	Rogowski/CT	Rogowski/clip	Rogowski/clip
600 V CAT IV	600 V CAT IV	600 V CAT IV	600 V CAT IV	300 V CAT III	600 V CAT III	600 V CAT IV	600 V CAT IV / 600 V CAT III
4	4	4	4	4	4	4	4
-	-	-	-	-	0.333 Vrms FS	-	-
4GB	4GB	4GB	4GB	4GB	8GB	4GB	16GB
via software	via software	via software	via software	via software	-	via software	via browser / SFTP
via software	via software	via software	via software	via software	via software	via software	via browser / SFTP
via software	via software	via software	via software	via software	-	via software	via browser / software
100...240 V AC 12 V DC	100...240 V AC 12 V DC	100...240 V AC 12 V DC	100...240 V AC 12 V DC	100...240 V AC 12 V DC	90...264 VAC	100...240 V AC 12 V DC	100 ... 240 V AC
3h	3h	2.5h	2.5h	3h	7h battery	3h	5 x 3 min
-	-	-	-	-	-	✓	✓ (L-N)
Ethernet Bluetooth	Ethernet Bluetooth USB WiFi	Ethernet Bluetooth USB WiFi	Ethernet Bluetooth USB WiFi	Ethernet Bluetooth USB WiFi	Ethernet, USB	Ethernet Bluetooth USB WiFi	Ethernet WiFi
Modbus	Modbus	WiFi	Modbus	Modbus	Modbus, BACnet	Modbus	Modbus



EVALUATION SOFTWARE FOR PQ MEASURING INSTRUMENTS

The following table shows which devices can be used together with which software. Please refer to the following pages for the scope of performance of the various software solutions.

DEVICE	Visualisation via Webbrowser	PQ-Diffractor	PQ-Easy Reporting	SMARTCOLLECT SC ²	DRAN-VIEW	PQVIEW	REST Interface
LINAX PQ SERIES	✓	✓	✓	✓	✓	✓	✓
SINEAX AM SERIES	✓			✓			✓
SINEAX DM5000	✓			✓			✓
SINEAX DM5S/F				✓			
APLUS				✓			
MAVOWATT 2XX	✓	✓			✓		
MAVOWATT 30		✓			✓		
DRANXPRT							
LINAX PQ5000 MOBILE	✓	✓	✓	✓	✓		✓
HDPQ SP	✓	✓			✓		
EXTERNAL DEVICES ¹⁾		✓		✓		✓	

1) After consultation with the software provider.

Please refer to the respective documentation for the individual devices and software functions.



PQ-DIFFRACTOR

FREE ANALYSIS SOFTWARE

- PQDIF viewer

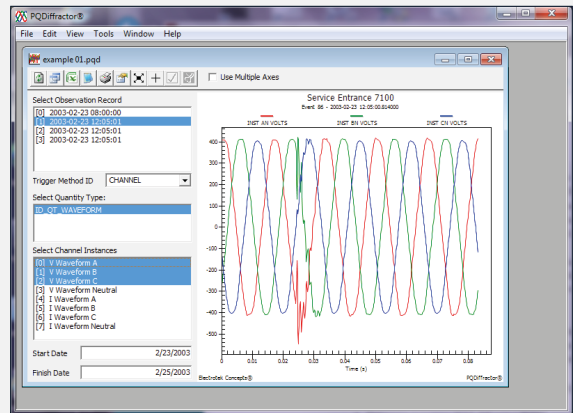

PQ-EASY REPORTING

CONFORMITY REPORTS POWER QUALITY VIA WEB BROWSER

- Power quality reporting for conformity evaluation of standards EN 50160 (6 variants), IEC 61000-2-2, IEC 61000-2-4 (3 variants), IEC 61000-2-12, IEEE 519, GB/T and customer-specific limits

The extent of the reports may be selected from three levels:

- Conformity overview
 - Overview with statistic details
 - Overview, statistic details and energy overview
- Introduction of a own company logo

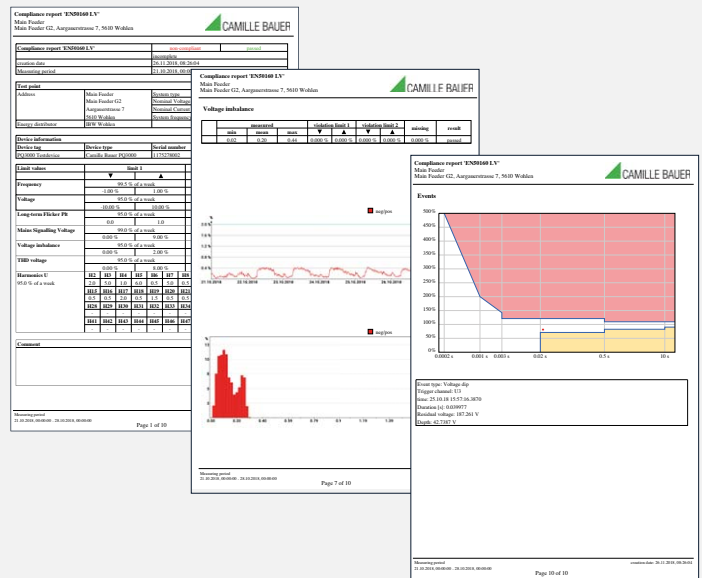

SMARTCOLLECT® SC²

STATIONARY GRID VISUALIZATION

- Interactive single line overview
- Functional dashboard
- Event and alert notifications
- Multi-device and brand data handling
- Individual WebGUI integration
- Energy Monitoring System (EMS)
- Sophisticated zoom function
- Interactive 2D/3D aerial view
- Multi-data communication
- Secure web-based system





DRAN-VIEW

SOFTWARE FOR GRID ANALYSIS

- Successful software used by thousands of customers
- Application based on Windows
- Easy and fast visualization and analysis of power and energy monitoring data
- Customer-specific functions and high-performance analysis function

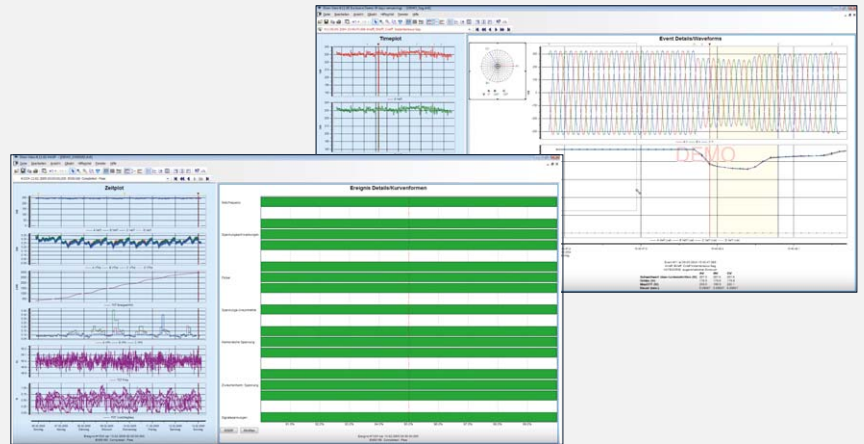

PQVIEW

INTELLIGENT SOFTWARE FOR POWER QUALITY ANALYSIS

- Works as system controller and user surface
- Automated communication with connected devices via supported communication methods
- Application from middle systems through to large multipoint, plant and supply monitoring
- Data like trends, real-time views and reports can be easily exchanged and checked, e.g. Word, Excel
- Client-, Server architecture (database)
- Web-based access possible
- Available in four application forms (PQView Starter, PQView Express, PQView Standard, PQView Professional)

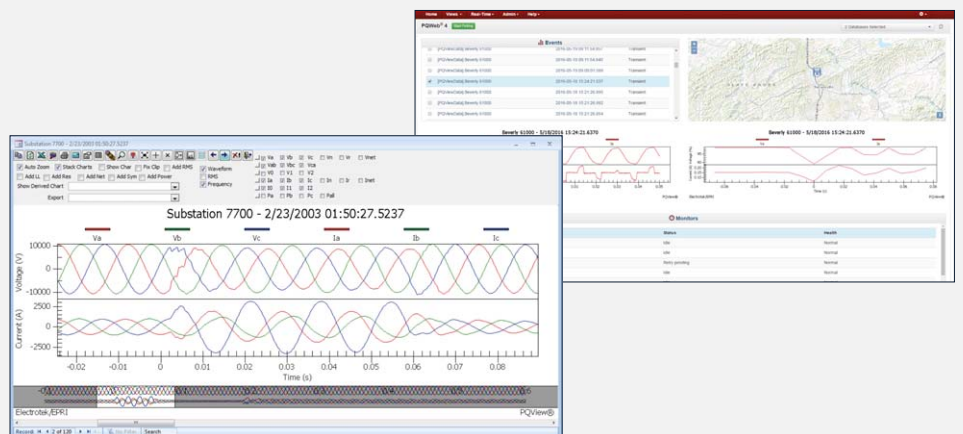



APPLICATION EXAMPLE

System for Energy Management, Power Quality and Pump Automation

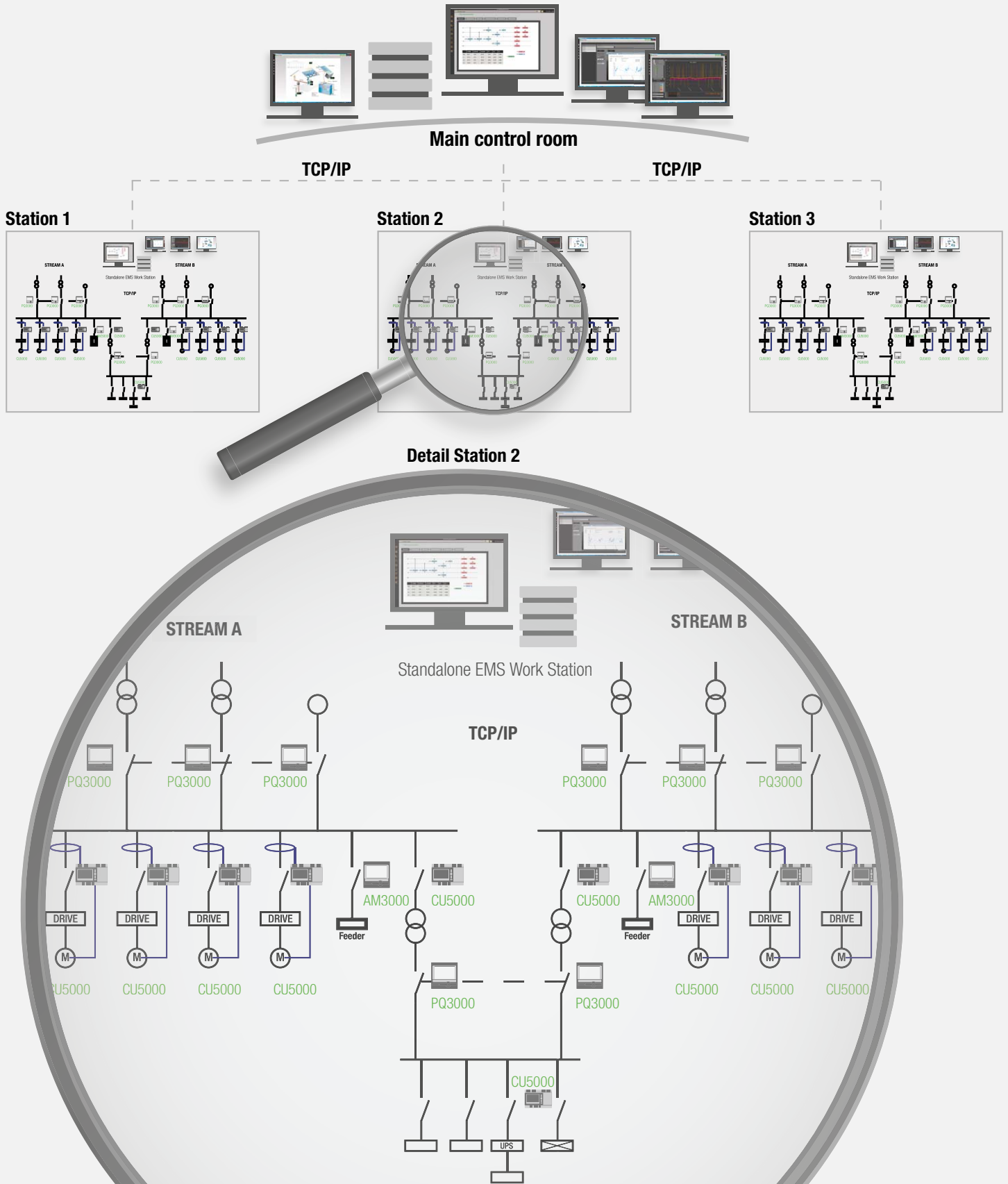



APPLICATION EXAMPLE

Visualisation and evaluation of measured data in distribution grid with alarm indication

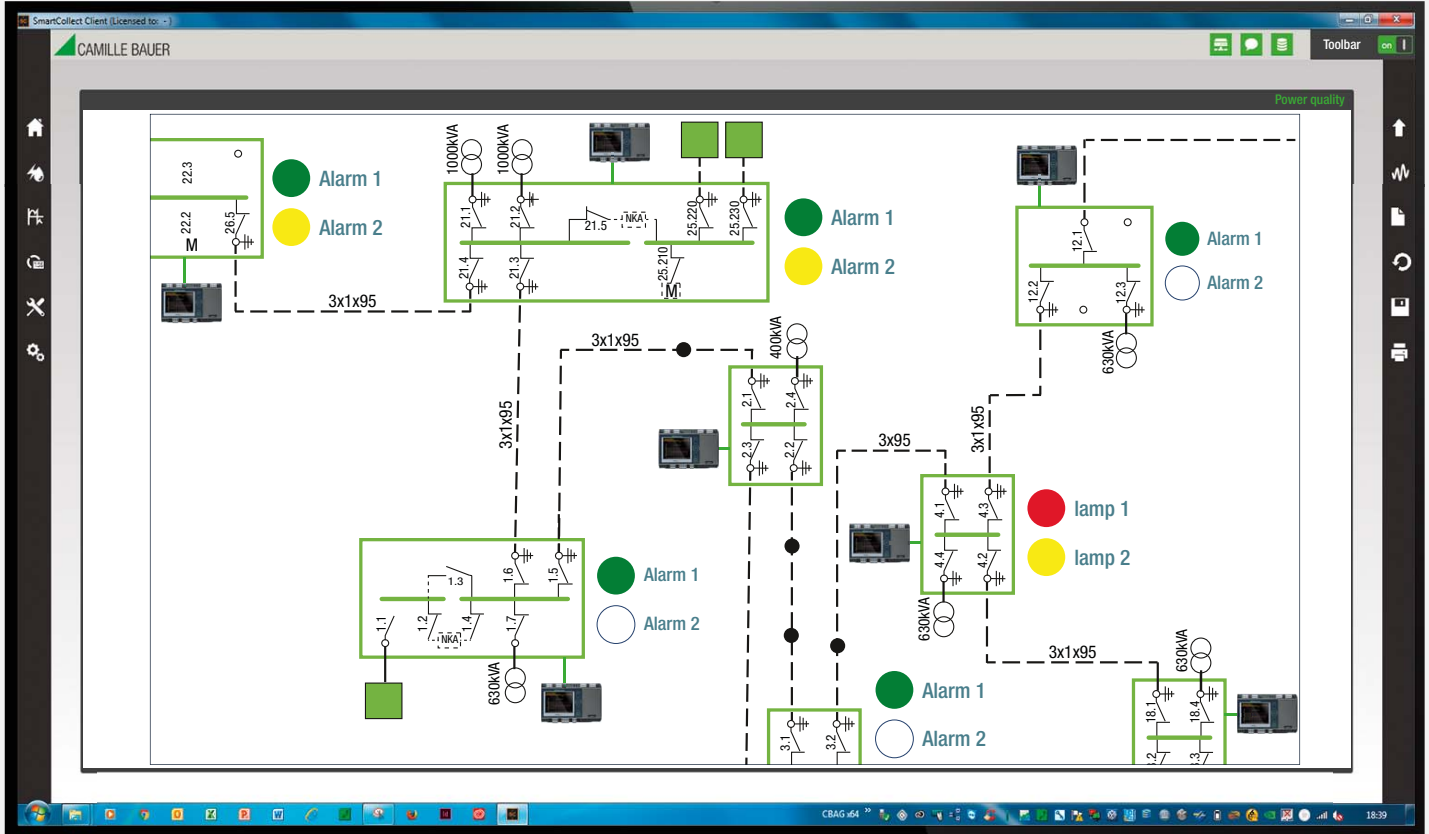

Alarm 1 (station)

● Everything OK or ● alarm on

Alarm 2 (confirmation)

● Alarm on or past or ○ no alarm

Substation community

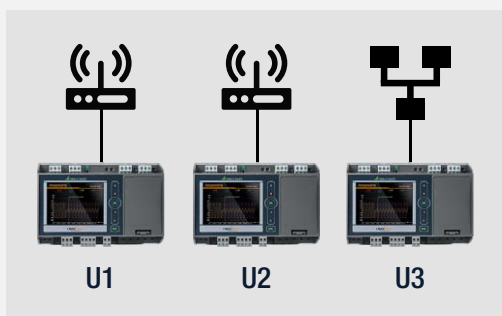

Headquarter

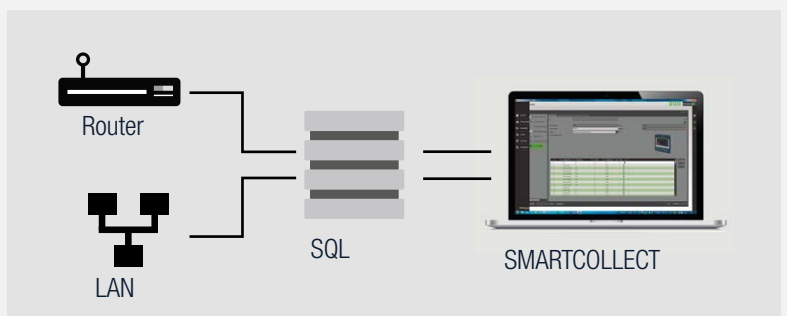

The systematic monitoring of distribution grids gives the operator a quick overview of the current situation of his grid and allows him to react immediately and purposefully to announcing or current problems.

A small SCADA systems with a complete overview, from where the ope-

rator can „click“ in each substation and query detailed informations are shown.

Alarms are immediately visible and must always be acknowledged even if they are no longer pending.

APPLICATION EXAMPLE

Power quality monitoring in data centers

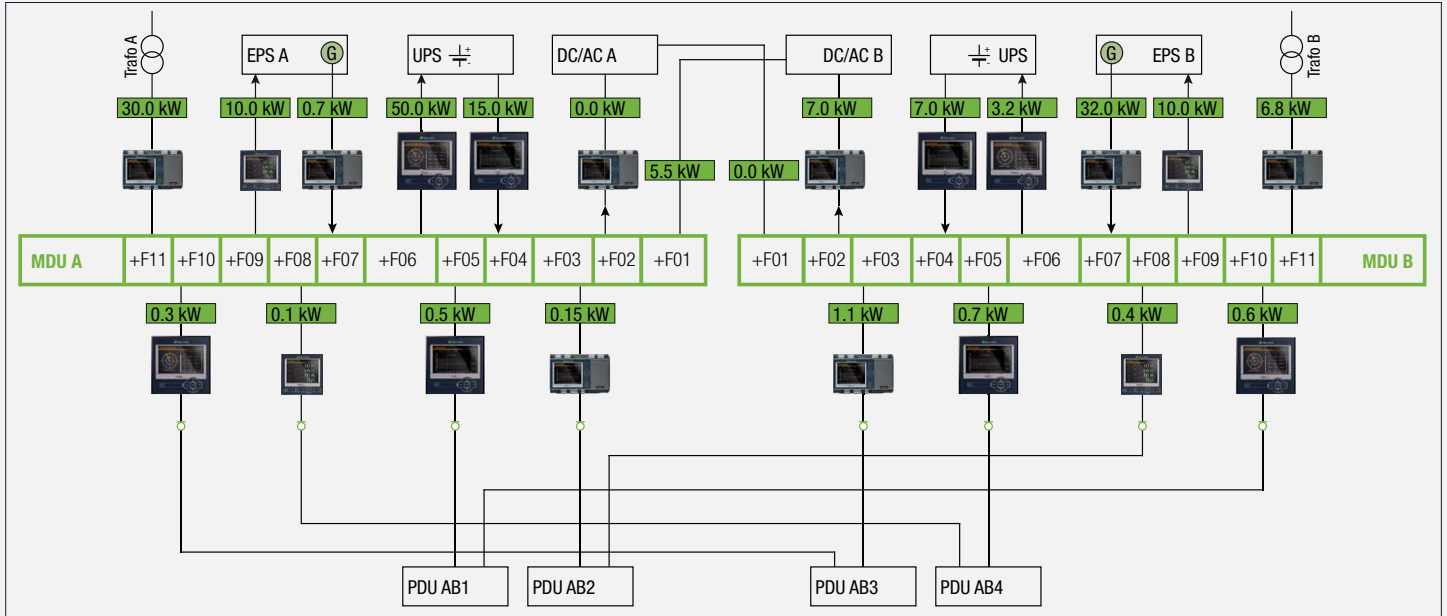

Data centers exist all over the world, not only as stand-alone operations but also in many other types of activity.

These include banks, insurance companies, industrial companies, hospitals, airports, energy providers, administrations, etc. The enormous energy requirements of these data centers confront both operators and energy providers with major challenges.

As with any data center operation, 24/7 availability is a fundamental requirement. Contracts have been signed with energy providers and measures to introduce further redundancy have systematically been put in place in order to ensure an uninterrupted supply of power. These include battery storage as well as generators and redundant supply lines into the data center. However as well as ensuring the supply of energy in sufficient quantity, the quality aspect has to be considered as well. This includes, depending on whether IEC standardization is specified or not (for example

according to IEC 61000-4-30, part 5.1 - 5.12, Class A) harmonic voltages, flicker, voltage dips and swells, transient voltages, rapid voltage changes (RVC), etc. These phenomena can cause lasting damage to servers and the infrastructure (for example uncontrolled machine shutdowns, generation of system defects, etc.) and it is essential to detect them early.

To allow these phenomena to be detected in a timely manner, the power quality needs to be continuously analyzed due to the fact that mains power supplies behave dynamically as a result of the constantly changing consumption and power feed-in situation caused by non-linear consumers (for example LED lighting, frequency-controlled air conditioning systems, the switching power supplies of the servers, etc.) and decentralized energy sources (for example if there are PV systems on the roof of the data center, etc.).



The energy for the data center is distributed over more than 50 switch-gear controlled circuits in the medium and low voltage domains .



APPLICATION EXAMPLE

Measurement of power quality and communication to the control center

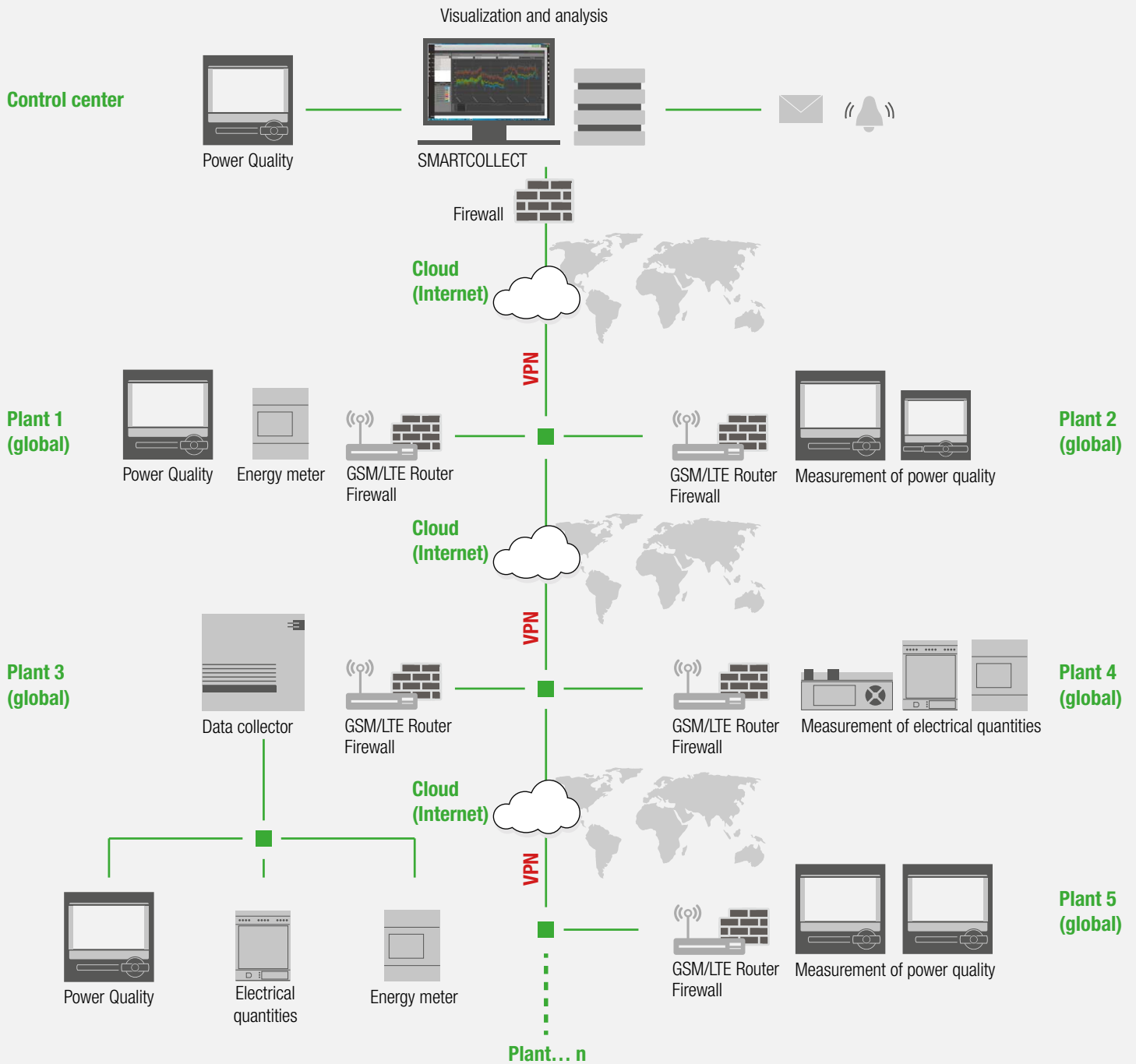

The power quality data of decentralized plants and factories can be transferred to the control center in various ways, where they can be centrally managed and evaluated.

A secure and reliable option is a Virtual Private Network (VPN) connection. This is a secure connection between the local network and the remote

measurement units, which is tamper-proof through the use of encryption. A VPN connection allows a complete bidirectional data exchange, but is limited to the devices integrated in this network.

WE RECOMMEND

Our solution partner Schaffner offers the entire portfolio of power quality solutions including line filters, passive and active harmonic filters and output filters. This approach offers extensive possibilities and solutions with a very good cost-benefit ratio.

Line filters

Line filters operated on the line side of drive systems protect converter electronics and indirect inverter capacitors efficiently against start-up, peak and short circuit currents. Furthermore, low-frequency disturbances and harmonics are distinctly reduced. In many cases, in which power chokes are combined with passive or active harmonic filters, we can offer technically and commercially optimised solutions.



Active and passive harmonic filters

Harmonic filters help to comply with international standards, e.g. IEEE 519-1992 or EN 61000-3-12 as well as local provisions of energy suppliers. They reduce the electrical and thermal stress on electro-infrastructure, exclude the risk of safety problems in connection with harmonics and support long-term energy efficiency and cost savings. Ecosine® passive filters are the industry standard in 6 pulse rectifiers and non-generative motor drives and achieve the frequently specified value of $< 5\%$ THDi. Active harmonic filters are suitable for mixed loads and dynamic applications. Ecosine® active filters are equipped with the latest digital technology. With a response time of less than $100\ \mu\text{s}$, effective attenuation of harmonics, power factor correction as well as a load balance is achieved in real time.

Output filters and load chokes

Output components for motor protection and improvement of plant safety, availability and functionality. Working on the output side of frequency converters, these filters facilitate unobjectionable operation by preventing expensive downtimes of plants, production facilities, machines and numerous further industrial and home motor drive applications due to premature motor damage. A suitable output solution even facilitates the use of unshielded motor cables, the parallel employment of several motors on the same drive or retrofitting of newly developed motors in plants with old equipment and unshielded wiring.



Just ask us: cbm-schaffner@camillebauer.com

YOUR DISTRIBUTION PARTNER

GMC INSTRUMENTS

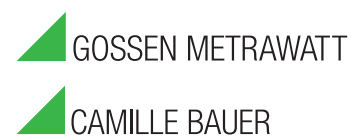

Camille Bauer Metrawatt AG
Aargauerstrasse 7 ■ 5610 Wohlen ■ Switzerland
TEL +41 56 618 21 11 ■ FAX +41 56 618 21 21

www.camillebauer.com ■ info@cbmag.com