

CORE RANGE INDUSTRIAL ENGINEERING

HEAVY CURRENT MONITORING
ROBUST POSITION SENSORS
POWER QUALITY
SOFTWARE SOLUTIONS

Measuring and Displaying



Position Sensors

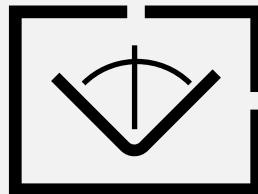

Power Quality



Monitoring and Controlling

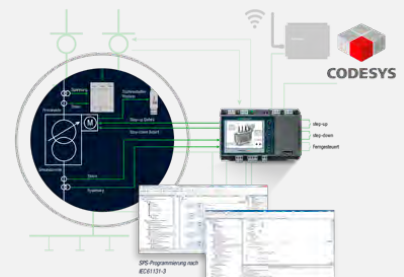
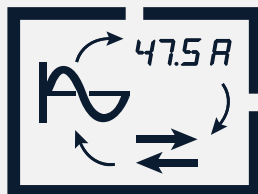

Software and Systems



**WELCOME TO
CAMILLE BAUER METRAWATT AG.**

Camille Bauer Metrawatt AG is a Swiss medium-sized company for the development and marketing of industrial measurement technology. Camille Bauer offers customer- and application-oriented solutions in the segment of electrical monitoring and position sensors. This includes a high understanding of the needs for electrical power generation, energy distribution as well as industrial consumers.

With its Swiss claim to the highest quality and its high innovative strength, Camille Bauer Metrawatt AG provides its customers with measurable benefits.



Camille Bauer Metrawatt AG is a company of the GMC-Instruments Group.

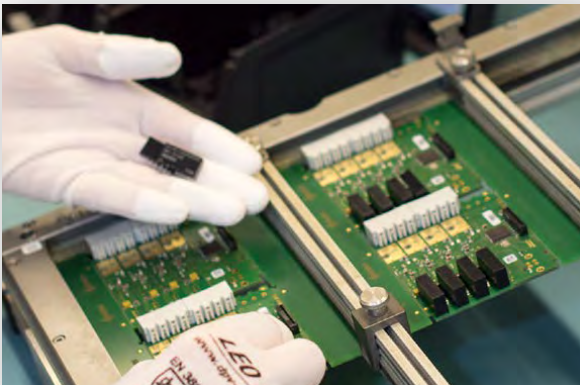

SWISS TOP QUALITY

At our location, we develop our own products. We are active internationally and export our products and services to destinations all over the world.

SUSTAINABILITY WITH A SYSTEM

- Resource-conserving raw material management
- Environmentally-friendly production processes
- Permanent further development of products and services under efficiency aspects
- Meticulous quality and environment compatibility tests
- Member of Cleantech Industry Association Switzerland
- Certified according to ISO 9001:2015 and ISO 14001:2015



The products in this catalogue are only an excerpt from our overall program.

PRODUCTS, SYSTEMS, SOLUTIONS FOR ELECTRICAL INSTRUMENTATION

ENERGY IS LIFE

You cannot imagine life today without electrical energy any more. Having this energy always reliably and in high quality available requires the well-conceived interaction between energy producers, grid operators and consumers.

Our products and services help you to devise your energy supply safely and reliably today and in future.

WHERE ARE WE ACTIVE

Power Quality

Proof of conformity

e. g. according to EN50160, IEEE519, GB/T, . . . , using certified class A power quality instruments

Fault identification using certified class A or class S power quality instruments

State monitoring using certified class A or class S power quality instruments

Capacity utilization by grid monitoring with certified power quality instruments of class A

Power Monitoring

Basic data acquisition for grid management by means of measuring transducers for U, I, F, P, S, Q, cos phi, . . .

Basic data acquisition for smart grid applications by means of synchronized mean values (industry, distribution system operator)

Real-time data acquisition in seconds as the basis for a fully computing-capable smart grid

Energy management

Energy data acquisition for monitoring and recording high-resolution energy data, including billing (MID)

Energy management as an instrument for strategic planning, monitoring and optimization to increase efficiency and reduce CO₂

Energy controlling as a process for the allocation of energy costs to various cost centres

Load management data for recording and optimizing grid utilization in an electrical grid (e. g. in production facilities, data centers, hospitals, . . .)

Power Quality as a Service (PQaaS)

Use case consulting providing the best possible solution

Complementary services, to round off solutions in a beneficial way, e. g. rental, calibration, . . .

Software and system solutions to support ecosystems

MEASURING AND DISPLAYING

Grid management and equipment monitoring require precise and reliable information of different grid variables. For this purpose, we offer a wide range of high-quality instruments to acquire all variables of the electrical grid. Our position sensors reliably acquire

mechanical positions, angles and inclinations. Supplemented by temperature transmitters and isolating amplifiers, our device portfolio is used throughout the entire measuring chain.



MEASURING AND DISPLAYING

- Programmable power instruments with process visualisation
- Unifunctional as well as multifunctional transducers for all electrical variables
- Energy meters
- Extensive process instrumentation for low-voltage signals
- Position sensors to acquire precise angle positions and inclinations

The **SINEAX® AM-series and the SINEAX® DM5000** devices are compact instruments to measure and monitor in heavy current grids. They excel in display quality and intuitive operation. The devices provide a wide range of functionalities which may even be extended by optional components. They are connected to the process environment by communication interfaces, via digital I/Os, analog outputs or relays.

The devices have been designed for universal use in industrial plants, building automation or in energy distribution. Nominal voltages of up to 690 V and measurement category CATIII can be directly connected in low voltage systems.



SINEAX® AM SERIES AND SINEAX® DM5000

- Direct measurement up to 690V, CATIII
- Condition monitoring
- Energy consumption analysis (meters, load curves, trend analysis)
- Harmonic analysis acc. IEC 61000-4-7
- System imbalance monitoring
- Limit monitoring with alarming
- Universal process I/O
- Graphical measurement displays
- High resolution color TFT display
- Device parameterization via WEB browser

	AM1000	AM3000	DM5000
Design	96 x 96 mm DIN rail	144 x 144 mm	DIN rail
Input channels voltage / current	3 / 3	4 / 4	4 / 4
MEASURED VALUES			
Instantaneous values	▪	▪	▪
Neutral current	calculated	measured / calculated	measured / calculated
Earth wire current (calculated)	–	▪	▪
Visualisation waveform U/I	▪	▪	▪
MEASUREMENT UNCERTAINTY			
Voltage, current	±0.2%	±0.1%	±0.1%
Active, reactive, apparent power	±0.5%	±0.2%	±0.2%
Frequency	±10mHz	±10mHz	±10mHz
Active energy (IEC 62053-21/22)	Class 0.5S	Class 0.2S	Class 0.2S
Reactive energy (IEC 62053-24)	Class 0.5S	Class 0.2S	Class 0.2S
DATA LOGGER (OPTION, ONLY WITH ETHERNET)	internal (≥8GB)	Micro SD card (≥16GB)	Micro SD card (≥16GB)
Disturbance recorder (with pretrigger)			
a) 1/2 cycle RMS progression U/I	≤3min.	≤3min.	≤3min.
b) Curve shape U/I [#cycles]	5/6 (pretrigger) +10/12	5/6 (pretrigger) +10/12	5/6 (pretrigger) +10/12
COMMUNICATION			
Standard I/Os	1 dig. OUT ; 1 dig. IN/OUT	1 dig. IN ; 2 dig. OUT	1 dig. IN ; 2 dig. OUT
Ethernet: Modbus/TCP, web server, NTP	▪	▪	▪
Relais	(Option)	(Option)	(Option)
Analogue outputs active / passive	(Option)	(Option)	(Option)
Digital inputs active / passive	(Option)	(Option)	(Option)
IEC 61850 / PROFINET IO	(Option)	(Option)	(Option)
RS485: Modbus/RTU	▪	▪	▪
RCM fault current detection	(Option)	(Option)	(Option)
GPS time synchronisation	(Option)	(Option)	(Option)
Temperature monitoring	(Option)	(Option)	(Option)
Uninterruptible power supply	--	(Option)	(Option)
PME CENTRAL UNIT	(Option)	(Option)	(Option)



DISPLAYING POWER METERS

The **APLUS** is designed for applications in power distribution, in strongly distorted industrial environments and in building automation. This powerful platform for the measuring, monitoring and analyzing of power systems is the ideal device for demanding measurement tasks, where fast, accurate and insensitive analysis of power systems and loads is required.



APLUS

- Acquisition and monitoring of system state quantities
- Universal process-I/O
- Open communication via Modbus, Ethernet or Profibus DP
- Long-term data storage with event recording
- Extended energy consumption monitoring
- Analysis of power quality aspects
- Monitoring means of production

You may select optionally either a TFT or LED display for on-site data visualization.

MULTIFUNCTIONAL DEVICES

The **SINEAX® CAM** is an universal, high-precision measurement system, which can be optimally adapted to the measurement task by means of the parameterization. Much emphasis was placed on the communication capabilities. So the device can be easily connected to a control system via analog and digital I/Os as well as standardized interfaces.



SINEAX® CAM

- Suited for monitoring strongly-distorted power systems
- Ideal for different test laboratory applications
- Communication via Modbus/TCP or IEC 61850 as an option
- Free assembly of I/O interface
- Optional internal or external display in 7 languages
- Version with Rogowski current inputs available
- Also available for mobile application

The **SINEAX® DM5S** and **SINEAX® DM5F** are classical high-accuracy transducers, suited for monitoring tasks and retrofit applications in energy distribution and industry. They provide either analog outputs and / or Modbus communication.



SINEAX® DM5S / SINEAX® DM5F

- System state monitoring: Class 0.2
- All-purpose: V/I, P/Q/S, f, PF etc.
- Remote communication via Modbus
- DM5S: Energy metering Class 0.5 S
- DM5F: Response time 15...25 ms
- Configuration without power supply

SIRAX® devices provide the basic functionalities of a measuring transducer at a low price.



SIRAX® BM1250 / SIRAX® BM1400

- BM1250: Well-visible one-line indication of measured data with backlit LCD display
- BM1400: Clear and unambiguous indication of measured variables with LED display
- Easy on-site operation and parameterization
- Communication via Modbus/RTU or TCP
- Automatic cyclical scrolling of measured data
- Integrated active and reactive energy meters, cost-effective alternative to energy meters (BM1250)



SIRAX® BT5700

- Well-visible two-line indication of measured data with backlit LCD display
- Easy on-site operation and parameterization
- Communication via Modbus/RTU or TCP
- Automatic cyclical scrolling of measured data
- Integrated active and reactive energy meters

The **SIRAX® BM1450** multifunctional DC energy meter can be used for monitoring and controlling in DC systems. These meters measure a wide range of electrical parameters such as DC voltage, current, power, energy and many more.



SIRAX® BM1450

- Multi-channel support
- Bi-directional voltage and current measurement
- Onsite configuration
- Communication via Modbus/RTU or TCP
- DC power system metering
- Monitoring and control power switches



UNIFUNCTIONAL DEVICES

This instrument series features the basic functionalities of a measuring transducer and is used as a cost-effective standard solution for the safe acquisition of measured variables in one-phase or three-phase heavy current systems. They convert a heavy current variable such as current, voltage, frequency or power, respectively, into a low-voltage signal (current or voltage).

MEASURING TRANSDUCER FOR VOLTAGE, CURRENT OR FREQUENCY



SIRAX® BT5100

Typ: Tension
Connection type: Single-phase

INPUTS

Nominal voltage [U_N]: 57 ... 500V
Voltage transformer primary value [PT]: 57 ... 400 kV
Nominal frequency: 45 ... 65 Hz

ANALOG OUTPUTS

Range: 0 ... 20 mA / 4 ... 20 mA or 0 ... 10 V

COMMUNICATION

Standard RS485: Modbus/RTU



SIRAX® BT5200

Typ: Current
Connection type: Single-phase

INPUTS

Nominal current [I_N]: 1 ... 5 A
Voltage transformer primary value [CT]: 1 ... 9999 A
Nominal frequency: 45 ... 65 Hz

ANALOG OUTPUTS

Range: 0 ... 20 mA / 4 ... 20 mA or 0 ... 10 V

COMMUNICATION

Standard RS485: Modbus/RTU



SIRAX® BT5210

Typ: Current
Connection type: Single-phase

INPUTS

Nominal current [I_N]: 1A, 5A
Nominal frequency: 50 or 60 Hz

ANALOG OUTPUT

Range: 0 ... 5 / 0 ... 10 / 0 ... 20 mA

AUXILIARY SUPPLY

Self powered



SIRAX® BT5300

Typ: Frequency
Connection type: Single-phase

INPUTS

Voltage transformer primary value [U_N]: 57 ... 500V
Nominal frequency: 45 ... 55 Hz, 48 ... 52 Hz, 55 ... 65 Hz, 45 ... 65 Hz

ANALOG OUTPUTS

Range: 0 ... 20 mA / 4 ... 20 mA or 0 ... 10 V

COMMUNICATION

Standard RS485: Modbus/RTU

MEASURING TRANSDUCER FOR POWER



SIRAX® BT5400

- Connection type: One-phase, 3-phase 3-wire balanced or unbalanced load or 3-phase 4-wire balanced or unbalanced load
- Measuring input for power
- Nominal voltage up to 500 V, nominal current 1 / 5 A
- 2 configurable analog outputs linear or kinked in a unipolar range of 0...20 mA / 4...20 mA or 0...10 V or a bipolar range of -20...0 mA or -10...0...+10 V
- Quick on-site programming using push buttons or via CB-Configurator software
- Simple on-site device operation
- Clear and well readable representation of measured data via LCD display
- Flexible communication and remote readout via integrated Modbus RTU interface
- DIN rail for top-hat rail mounting

PROGRAMMABLE TAP POSITION TRANSDUCER (TAP)



SIRAX® BT5600

- Input measuring range can be programmed using PC /Simplifies project planning and engineering (the final range can be determined during commissioning)
- Electrically isolated Dual outputs
- Tap number is programmable from 1 to 100 using software
- Tap position is displayed on front LED display
- Analogue output signal also programmed using the PC (impressed current or superimposed voltage for all ranges between - 20 and + 20 mA DC resp. - 12 and + 15 V DC)
- Galvanic and optical isolation between Power supply, Input and outputs
- 3,4 wire measurement to compensate lead resistance automatically
- 2 wire measurement with lead resistance compensation through software

MOBILE CURRENT DATA LOGGER



METSyS NEC 220

METSyS is a cost-effective, easy-to-use 3-phase RMS current data logger that is ideal for any load study application.

- METSyS is a portable true RMS current data logger (no voltage connection)
- 3-phase current. Optional 4-phase Rogowski coil bundle
- Sampling of an 8-cycle window of current on 3 or 4 channels. A, B, C + optional neutral wires
- User selectable recording intervals - 10s, 30s, 1m, 5m, 10m, 15m, 30m, 60m
- Records minimum, maximum, average and peak currents for each interval
- Records to 2 GB internal memory. Non-volatile data storage
- A 2-line LCD display for real-time measurements, easy setup and data transfer



ANALOG DISPLAY METERS FOR DISPLAYING THE MOST IMPORTANT ELECTRICAL DATA

ONLY ON REQUEST

Camille Bauer Metrawatt AG offers a wide range of analog display meters for almost all applications. A wide variety of instrument types, housing dimensions and scales are available for panel, machine and mosaic grid mounting.

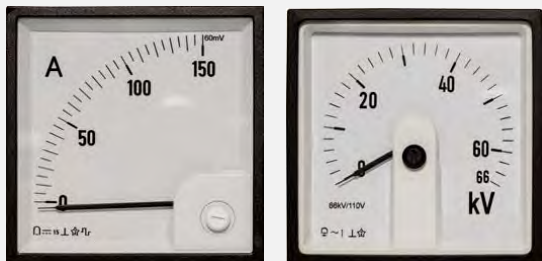
**Features:**

- UL 94 V-0 approved glass-filled polycarbonate housing with self-extinguishing and non-dripping material.
- Available in four different enclosure sizes (48, 72, 96, 144)
- Scales are interchangeable
- Complete back protection cover as a standard accessory for user safety
- Mechanical, shockproof spring, pivot and bearing jewel movements are used
- AC meters are supplied with interference suppression scales
- Easy installation with metal clamps

Device type	Type of scale	Designation	Bezel size	Measured parameters	Measuring range	Accuracy
Rotary iron	90°	SIRAX® BM100	□48mm / □72mm / □96mm / □144mm	Alternating current / voltage	100mA ... 100A ... / 5A (for transducer) ... / 1A (for transducer) 6V ... 1000V ... / 100V (for transducer) ... / 110V (for transducer)	1.5% (from reference value)
Rotary iron with switch	90°	SIRAX® BM150	□72mm / □96mm	1- or 3-phase alternating current / voltage	1A / 5A 100V ... 600V	
Moving coil	90°	SIRAX® BM200	□48mm / □72mm / □96mm / □144mm	Direct current / voltage	15µA ... 100A 4 ... 20mA (for transducer) 15mV ... 1000V 60mV ... 150mV (for Shunt)	
	Measured para- meters	SIRAX® BM250			50µA ... 100A 4 ... 20mA (for transducer) 60mV ... 600V 50mV ... 150mV (for Shunt)	
Moving coil with rectifier	90°	SIRAX® BM300	□48mm / □72mm / □96mm / □144mm	Alternating current / voltage	100µA ... 10A ... / 5A (for transducer) ... / 1A (for transducer) 6V ... 600V ... / 100V (for transducer) ... / 110V (for transducer)	
	Accuracy	SIRAX® BM350			100mA ... 10A ... / 5A (for transducer) ... / 1A (for transducer) 6V ... 600V ... / 100V (for transducer) ... / 110V (for transducer)	
Moving iron or moving coil for standard rail mounting	90°	SIRAX® BM400	□45mm (45 x 85 x 57mm)	Alternating or direct current, alternating or direct voltage	1ma ... 15a ... / 5A (for transducer) ... / 1A (for transducer) 100mV ... 600V ... / 100V (for transducer) ... / 110V (for transducer)	

Device type	Type of scale	Designation	Bezel size	Measured parameters	Measuring range	Accuracy
Bimetal	90°	SIRAX® BM500	□72mm / □96mm	Alternating current	1A / 5A 1A...10000A / 1A 1A...10000A / 5A	3% (from reference value)
Bimetallic/ bi-metal moving iron		SIRAX® BM550				
Moving coil with built-in transformer	90°	SIRAX® BM600	□72mm / □96mm	45...50...55 Hz / 45...55...65 Hz / 45...60...65 Hz 360...400...440 Hz / 380...400...420 Hz	57.7V ... 500V	0.5% (from reference value)
	240°	SIRAX® BM650	□96mm / □144mm			
	90°	SIRAX® BM700	□72mm / □96mm	COSφ cap 0.5...1...0.5 ind COSφ cap 0.8...1...0.3 ind COSφ cap 0.8...1...0.8 ind	1A / 5A	1.5% (from reference value)
	240°	SIRAX® BM750	□96mm / □144mm			
Moving coil with built-in transducer	90°	SIRAX® BM800	□96mm	Specify when ordering	5A ... 200000A / 1A 5A ... 200000A / 5A 57.7V ... 500V	1.5% (from reference value)
	240°	SIRAX® BM850				
Roller counter with synchronous motor	90°	SIRAX® BM900	□72mm / □96mm	00000.00 ... 99999.99	100 ... 125 VAC 200 ... 250 VAC 380 ... 440 VAC	±0.02s in 24 h
2 in 1 moving iron	90°	SIRAX® BM910	□72mm / □96mm	1A / 5A 1A...10000A / 1A 1A...10000A / 5A	100mA ... 60A ... / 5A (for transducer) ... / 1A (for transducer) 6V ... 600V ... / 100V (for transducer) ... / 110V (for transducer)	3% (from reference value)
Sychronoscope	--	SIRAX® BM920	□96mm / □144mm	35 ... 70 HZ	100 ... 500 VAC	--
Moving coil with built-in transducer	Tongue- move- ment	SIRAX® BM930	□72mm / □96mm	--	--	1.5% (from reference value)





PROCESS CONTROL ENGINEERING

To ensure a continuous and steady process, and to store, manage and visualize process data, we offer a wide portfolio of signal converters and Process-Management-Systems.



SINEAX® V604s Programmable multifunctional transmitter

- Measurement of DC voltage, DC current, temperature (RTD, TC) and resistance
- 2 inputs (e.g. for sensor redundancy or subtraction)
- 2 outputs (U and / or I)
- System capability: Communication via Modbus interface
- Freely programmable relay, e.g. for limit or alarm signalling
- AC/DC wide-range power supply unit
- Due to intelligent mathematical functions applicable for:
 - DC energy metering
 - Power measurement
 - Load monitoring
 - Difference monitoring
 - Redundant temperature measurement
 - Signal adaptation
 - Gradient / limit value monitoring

VIDEOGRAPHIC RECORDERS

The latest generation of paperless Camille Bauer videographic recorders are modular and may thus be adapted individually to the requirements of the most varied applications.

Today videographic recorders are not used for data recording only, but also as powerful indicators, intelligent interfaces between different signal transmission and bus systems (e.g. 4...20 mA to Modbus) and as intelligent and independent computing units on site.



LINAX® DR2000 Videographic recorder

- Inexpensive videographic recorder for basic applications
- Very distinct, high-quality TFT display
- Device can be equipped and extended according to customer requirements
- Device protection IP65 / NEMA4 device protection (front)
- Fast scanning of 100ms/channel
- Low operating costs (TCO)



LINAX® DR3000 Videographic recorder

- Powerful videographic recorder with high performance
- Simple intuitive operation, with built-in Help
- Up to 12 mathematics channels for complex calculations
- For applications in rough environment due to IP65 / NEMA4 device protection (front)
- Data security in accordance with FDA 21 CFR Part 11
- Guaranteed data integrity (flash memory)
- Low operating costs (TCO)

TRANSMITTERS FOR ANGULAR POSITION



KINAX® WT720 Absolute, programmable shaft transmitter for angular position for applications in rough environments, diameter 58 mm

- Robust transmitter version suitable for field applications
- Absolute value angular transmitter
- Capacitive measuring system
- Low wear and maintenance free
- Safe electrical connection thanks to spring-type clamp and reverse polarity protection
- Sturdy against high mechanical loads
- High degree of sealing against water and dust (housing protection class IP67/IP69K)
- Measuring range linear or V-characteristic free programmable
- Interface analog 4 ... 20 mA (2-wire connection) / center position 0° = 12 mA
- Available with explosion protection „Ex ia IIC T4 Gb“, „Ex ia IIIC T80°C Db“ and „Ex tb IIIC T80°C Db“ according to ATEX and IECEx
- With maritime execution (formely GL, Germanischer Lloyd) available



KINAX® HW730 Absolute, programmable hollow-shaft angular position transmitter for applications in rough environments, diameter 78 mm

- Robust hollow shaft angular transmitter suitable for field applications
- High absolute accuracy ($\pm 0.35^\circ$) thanks to capacitive 2-wire technology
- Low wear and maintenance free
- Safe electrical connection thanks to spring-type clamp and reverse polarity protection
- Sturdy against high mechanical loads
- High degree of sealing against water and dust (housing protection class IP67/IP69K)
- Flexible and easy to install thanks to hollow shaft up to 30 mm
- Measuring range linear or V-characteristic free programmable
- Interface analog 4 ... 20 mA (2-wire connection) and digital Modbus with PoE
- Easy, variable installation thanks to hollow shaft \varnothing 30/20/16/12/10 mm
- Available with explosion protection „Ex ia IIC T4 Gb“, „Ex ia IIIC T80°C Db“ and „Ex tb IIIC T80°C Db“ according to ATEX and IECEx
- With maritime execution (formely GL, Germanischer Lloyd) available



KINAX® WT707 / WT717 Absolute shaft angular position transmitter for applications in rough environments, diameter >100 mm

- Robust single- or multiturn angular transmitter suitable for field applications
- Absolute value angular transmitter
- Sturdy against high mechanical loads
- Low wear and maintenance free
- Programmable and non-programmable versions
- Interface analog 4 ... 20 mA
- Available with explosion protection „Ex ia IIC T6 Gb“, according to ATEX and IECEx
- With maritime execution (formely GL, Germanischer Lloyd) available
- Available in sea-water resistant version
- Also available with gear ratio up to 1600:1

TRANSMITTER FOR ANGULAR POSITION

KINAX® 3W2 / 2W2 Absolute shaft angular position transmitter to be installed

- Compact version to be installed into other equipment and apparatus
- Absolute value angular transmitter
- Low wear and maintenance free
- Small starting torque < 0.001 Ncm
- Programmable and non-programmable versions
- Interface analog 4 ... 20 mA (2-wire connection)
- Available with explosion protection „Ex ia IIC T6 Gb“, according to ATEX and IECEx
- With maritime execution (formerly GL, Germanischer Lloyd) available

INCLINATION TRANSMITTERS

KINAX® N702 Programmable inclination transmitter unidimensional

- Robust inclination transmitter suitable for field applications
- Absolute position always available
- Magnetostrictive measuring system
- High degree of absolute measuring accuracy ($\pm 0.2^\circ$)
- Unidimensional oil-damped pendulum system
- Measuring range and sense of rotation free programmable
- Interface analog 4 ... 20 mA or digital SSI
- Easy installation and commissioning

KINAX® N702 INOX Programmable inclination transmitter

- Hermetic watertight and dust-proof housing IP68/IP69K
- Optimally resistant to aggressive media such as sea water and detergents
- Stainless steel housing INOX AISI 316Ti (1.4571)
- High degree of absolute measuring accuracy ($\pm 0.2^\circ$)
- Resistant against high mechanical strains thanks to robust design and high quality materials
- Safe electrical connection through flexible control cable
- Standard synchro flange or mounting plate
- 2-wire connection via flexible control cable
- Free parameterization via control line
- Interface analog 4 ... 20 mA or digital HART



ENERGY MONITORING

Acquiring, evaluating and optimizing the energy consumption and its allocation to incurring cost centres constitutes a central task of any company. To enable its recognition on all levels, we offer all of the required components, from energy meters and summators through to the analysis and billing software.



Energy automation Measure - Control - Visualize

- **Intelligent summator**

The CENTRAX® collects freely selectable data from various devices via Modbus/TCP, Modbus/RTU or also via impulse from energy meters. The data can be stored, combined into individual packets and communicated to a higher-level system.

- **Submetering, Gateway**

Submetering, Gateway Gateway between Modbus/RTU and Modbus/TCP. Via the IP address of the CENTRAX®, each device can be identified by its device address. Thus the RTU devices can be queried and respond directly.

- **Collect, log and evaluate data**

Up to 16 counters can be connected to the CENTRAX® via pulse output. If the meter constant is known, the energy and power can be calculated directly from the pulses over time. Thus, even the simplest meters become smart meters.



Energy Meters ENERGMID

- Professional energy counters for 2-, 3-, 4-wire systems with up to 80 A direct or 1 A, 5 A transformer connection
- Flexible communication and remote readout thanks to a broad range of interfaces such as LON, M-Bus, Modbus RTU, Ethernet, BACnet or pulsed output
- Maximum transparency through multifunctional design for the acquisition of reactive energy and other measured variables in the grid
- Integrated connection error diagnose for simple and time-saving installation
- Adaptable to future rate structure in the energy market thanks to the possibility of setting up to 8 different rates

ENERGY METER

The SIRAX® MT7100 / MT7150 is an «All in One» three-phase power meter with integrated energy meter and universal current input. It is designed for DIN rail mounting and common current and voltage transformers and Rogowski coils can be connected.



SIRAX® MT7100 / MT7150

- Break-proof plastic housing made of PBT
- Flame retardant and self-extinguishing according to UL94 V0
- Common current and voltage transformers and Rogowski coils connectable
- Configuration via configuration software
- Serial RS485 Modbus/RTU output
- DIN rail mounting for vertical or horizontal position
- Available as a set with Rogowski coil ACMF 1603_1/3



METRALINE ENERGY

The METRALINE Energy series active energy meters enable energy data acquisition for a wide range of applications. Thanks to integrated and expandable interfaces and their compact design, these MID-certified energy meters are the perfect solution when every centimeter counts - and they are cost-efficient.





CURRENT TRANSFORMER

When recording electrical energy consumption, the corresponding currents must be measured. This is done by means of measuring current transformers, which convert a primary rated current into a galvanically isolated secondary rated current of 5A or 1A that can be used by the measuring system. To be able to guarantee the quality and accuracy of a measurement, a suitable combination of a transformer and a measuring device is very important.

Regardless of the required nominal size, the accuracy class, the size of the conductors or the available space, Camille Bauer Metrawatt has a wide delivery range of different current transformers according to IEC 61869-2.



Winding current transformers

Winding current transformers convert small primary rated currents from 1 A into galvanically isolated secondary rated currents of 5 A or 1 A which can be used by the measuring system. In contrast to clip-on or cable-type current transformers, wound current transformers have 4 screw terminals. The primary current as well as the secondary current are connected via terminals.



Plug-on current transformers

Plug-on current transformers are used wherever high currents are to be recorded and further processed. They are plugged directly through the opening onto the primary conductor (busbar or line). The secondary side (usually a measuring device, energy meter or display) is connected through the terminals on the front and back.



Cable conversion current transformer

Thanks to their compact design and easy installation, cable conversion current transformers are particularly suitable for use in hard-to-reach places and where space is limited. The separable core halves additionally facilitate installation on the cable or on the rail.



Summation current transformer

If the current measurement is carried out via several current transformers to record a total consumption, the secondary currents of the individual current transformers are added up and the sum divided by the number of summands (number of inputs). This means that the total consumption can only be recorded with one measuring instrument. A standardized measuring signal (5 A) is available at the output of the summation current transformer.



Plug-on current transformer for PQ

Plug-on current transformers for power quality applications ensure reliable transmission at a sampling rate of up to 20 kHz. They are designed for harmonics up to 9 kHz.



Plug-on differential current transformers

The plug-on differential current transformers of the «DACT» type A series detect very small currents. In connection with our device variants SINEAX® DM5000, AMx000, CENTRAX® CUx000 and LINAX® PQx000 they can be used for differential and residual current monitoring of machines and plants.



Cable conversion residual current transformers

Wherever an interruption of the current path is problematic or a measuring device has to be retrofitted in an uncomplicated way, these transformers are the right choice. They detect very small currents. In combination with our device variants SINEAX® DM5000, AMx000, CENTRAX® CUx000 and LINAX® PQx000 they can be used for residual and fault current monitoring of machines and plants.



AC/DC Current Transformers with Transmitter Functionality

The SIRAX® BT7000/BT7050 and SIRAX® BT7100/BT7150 series are current transformers with integrated measuring transformer functionality for monitoring 1-phase AC or DC applications. The current measurement is galvanically isolated from the measured line. The large number of measured variables, the maximum current of up to 300 AAC or 400 ADC allow a versatile use of the devices.



AC/DC current transformers with energy meter functionality

The SIRAX® BT7200/BT7250 and SIRAX® BT7300/BT7350 series are current transformers with integrated energy meter functionality for monitoring 1-phase AC and DC applications. The large number of measured variables, the maximum current of up to 300 AAC or 400 ADC at maximum 1000 VDC or 800 VAC, respectively, allow the devices to be used in a wide range of applications.



Divisible Current Transformers

Wherever an interruption of the current path is problematic or a measuring device needs to be retrofitted in an uncomplicated way, cable conversion current transformers are the right choice.



Rogowski current sensors

Rogowski coils are air-core coils. The magnetic field of the wrapped current-carrying conductors induces an alternating voltage in the coils which is proportional to the current. This is determined by integration of the voltage. For that an electronic circuit is required, which needs to be powered. The great advantage of Rogowski coils is the quick and easy installation, without the need to disconnect current circuits. By means of switchable current measurement ranges almost any application may be covered without any variance. The principle also allows to measure fast current changes and harmonics a lot better than any conventional current transformer.



Current clamps

Measurement category: 600 V CATIII
 Frequency range: 30 Hz up to 10 kHz

	Current clamps 10A/1V	Current clamps 100A/1V	Current clamps 1000A/1V
Current range CR:	10 mA up to 10 A AC	1 A up to 120 A AC	1 A up to 1200 A AC
Output sensitivity:	100 mV/A	10 mV/A	1 mV/A

Shunts

ONLY ON REQUEST

The shunts are used to measure DC currents, especially at high current levels.

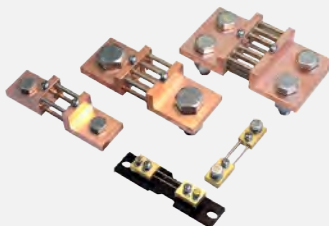

- Primary current ratings from 1A ... 15000A available
- Voltage drop 50mV, 60mV, 75mV, 100mV and 150mV available
- Rugged construction
- High accuracy class 0.2 and 0.5
- Busbar mounting
- High overload resistance
- Very low temperature coefficient
- High long-term stability
- Shock and vibration resistant

POWER QUALITY

Modern power electronics and non-linear consumers increasingly impair the electrical grid which is the reason why alternating current has not shown the original sinusoidal characteristic already for a long time. This bears heavily on electrical devices and machines and extends to higher thermal losses, increased energy consumption through to the disturbance and downtime of plants. Our solutions ensure that problems are early recognised, even before they occur.

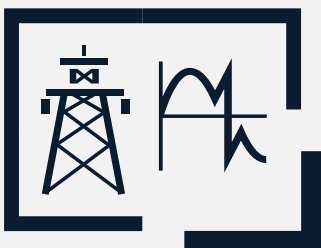

POWER QUALITY

- Certified power quality analysis according to IEC 61000-4-30 Ed. 3 in class A
- Certified energy flow analysis with accuracy class 0.2S
- Data export to PQDIF and CSV, periodically or event-driven
- REST interface, IEC 61850, Profinet, Modbus RTU/TCP
- PQ Easy-Report conformity reports without additional software (e.g. EN 50160, GB/T, IEEE 519, IEC 61000-x-x, user defined, ...)
- Role-based access control, encrypted communication and secure logging of security-related events



24/7 - STATIONARY MEASUREMENT OF POWER QUALITY

Traditionally, power quality monitoring is only conducted as a reaction to trouble such as device failure, plant malfunctions, process interruption or communication breakdown. However, all these problems cost money and nobody wants to experience the same thing again just to be able to create a corresponding record for analysis. Therefore, the greatest advantage of continuous power quality monitoring is that users put

themselves in a position to proactively build up their knowledge thus increasing system availability. Devices such as **LINAX® PQ1000 / PQ3000 / PQ5000** help to detect trouble before it can do any damage and to provide data for the identification of the root cause in case an event actually occurs.

Measuring instruments for power quality monitoring, metrologically certified



LINAX® PQ1000

The system for power system analysis

- Power quality analysis in class S according to IEC 61000-4-30
- Conformity assessment in distribution networks and IPCs according to common standards and own limit values
- Design variants (top hat rail mounting with/without display, panel mounting 96 x 96 mm)



LINAX® PQ3000/PQ5000

Compact devices for power quality monitoring in electrical grids

- Certified power quality analysis in Class A, according to IEC 61000-4-30 Ed. 3
- Data exchange for power quality data: PQDIF
- PQ conformity reports via website possible without any external software

ONLY ON REQUEST



LINAX® PQ5000-RACK

Power quality monitoring in the electrical system in a 19" rack according to EN 60297

- Certified power quality analysis in Class A, according to IEC 61000-4-30 Ed. 3
- Analyzing of two power systems (e. g. double busbar, transformer)
- Optional data transmission via cellular network and synchronization via GPS
- Current measurement via current transformer (1/5 A) or small signal sensors (<3 V)





MOBILE MEASUREMENT OF POWER QUALITY



LINAX® PQ5000-Mobile

By means of the mobile measurement solution **LINAX® PQ5000-Mobile** the operational aspects of the energy supply can be verified:

- Quality of supply
- Availability of supply
- Evaluation of changes or improvement measures
- Energy flow analysis

This measurement solution supports campaigns (repeated measurements at the same location) by a configuration manager with up to 20 storable device settings, can provide a WLAN access point for connecting mobile devices and provide all data for evaluation via the device's own website. In order to be able to validate the power quality at the measuring location, the duration of the measurement should be at least 7 full days.



LINAX® PQ5000MOBCL / LINAX® PQ5000CL-MultiPQ

The portable load flow meter **LINAX® PQ5000MOBCL** for the simultaneous and accurate recording of all load profiles, including recording the voltage quality.

- Time-synchronous recording and analysis of up to 9 outgoing feeders simultaneously
- Only one measuring device instead of nine expensive individual devices saves money
- Only one measuring device reduces the installation effort enormously and saves time
- Only one evaluation instead of nine individual reports increases efficiency

The portable power quality and load flow meter

LINAX® PQ5000CL-MultiPQ for simultaneous and feeder-specific recording of all load profiles, **including comprehensive power quality analysis per feeder.**

- Comprehensive analysis of the power quality for all outgoing circuits (MultiPQ only)
- Time-synchronous recording and analysis of up to 9 outgoing feeders simultaneously
- Only one measuring device instead of nine expensive individual devices saves money
- Only one measuring device reduces the installation effort enormously and saves time
- Only one evaluation instead of nine individual reports increases efficiency



HDPQ®

Power Quality Analyzer Class A with touchscreen including Wi-Fi, fast transient recorder (1µ) and with 400Hz monitoring!

- Detects and records sags/dips, surges, interruptions, transients, harmonics, flicker, RVC and more - Meets and exceeds industry standards
- Tests 400 Hz & 50/60Hz - Specialized aircraft, marine and other applications AND standard current monitoring

A METROLOGICAL COMPASS FOR SMART GRIDS

Fundamental measurement technology from the «bottom up» forms the basis for cellular energy systems and thus also smart grids in order to be able to stabilize grids (e.g. due to prosumer behavior, switching off grid mass, etc.). Here, not only scalability is important, but also absolute future viability, e.g., through flexible connectivity, function adaptations, etc.

We propose a certified power quality measurement and power analysis up to 32 channels in the sub-distribution. The signal processing is

implemented on the measuring device of the LINAX® PQ5000CL series. There, the respective current measured values of the so-called Current Link modules are processed. Thanks to the Current Link technology, the individual Current Link modules and their sensors (Rogowski) are networked in a scalable manner by means of a signal loop via coaxial cables. This reduces the installation effort to an absolute minimum and ensures proper cable routing. In addition, this measuring system for

determining power quality and load flows is extremely cost-efficient and metrologically certified on top. Thus, the scalable measuring instrument virtually combines the areas of transducers according to IEC 60688, power metering and monitoring according to IEC 61557-12 as well as power quality instruments according to IEC 62586-1.

LINAX® PQ5000CL

- Metrologically certified PQI according to IEC61000-4-30 Ed. 3 class A as basic device
- A scalable system for the areas of certified power quality as well as for load and efficiency management for up to 10 feeders (32 Leaders)
- An optional basic current measurement (e.g. directly after the transformer) with a high accuracy due to current transformer sensors
- 3 or 4 channels via Current Link per feeder (max. 32 currents)
- Simultaneous measurement of multiple feeders instead of traditional per feeder measurement
- Direct compliance reporting and event display by PQEasy reporting via web browser (e.g. according to EN50160)
- Time-synchronous fault recording of voltage events with currents of the individual channels (IEC61000-4-30 Ed. 3)
- Time synchronous load management for U/I/P/Q/cosφ
- Current measurement per Current Link channel «IN1 (typical/maximum) of 400 A / 1'000 A» and «IN2 (typical/maximum) of 8'000 A / 20'000 A»
- Grid tariff meter P & Q (purchase & delivery)
- System management by means of a user-friendly multi-device tool for easy commissioning and efficient maintenance
- Low space requirement due to single voltage measurement
- No need to shut down the plant for installation of the measuring system due to the non-invasive Rogowski measuring technique
- Very high robustness due to proven coaxial principle
- Current values are time synchronous to voltage (IEC61000-4-30)
- Various communication interfaces (Modbus TCP/IP, Modbus RTU, REST API, IEC61850, Cloud with MQTT, Webbrowser) allow high connectivity flexibility to parallel as well as higher-level systems
- Fast roll-out with robust measurement technology
- Sampling rate 54 kHz (zero blind technology)

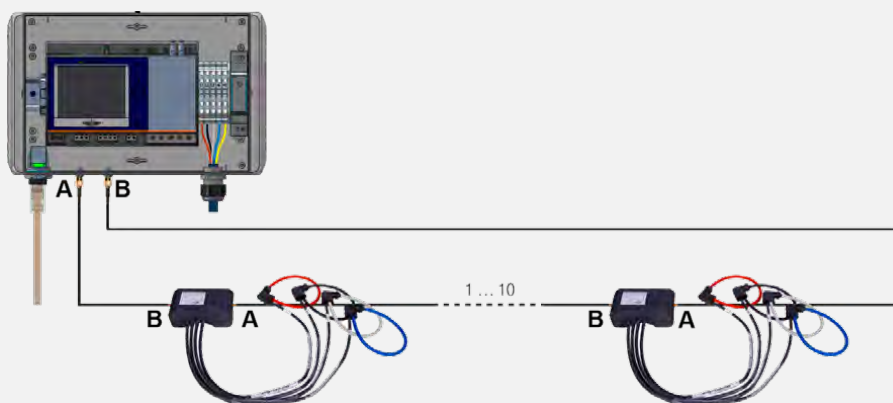

LINAX® PQ5000CL-3 in field housing with connected Current Modules 3PN



INTELLIGENT MEASUREMENT AND CONTROL SOLUTIONS FOR THE DISTRIBUTION GRID

Various solutions are possible depending on the use case.

Common features of the SmartGridBox variants (use case 1-3):

- Voltage and grid status recording
- Monitoring and recording of voltage events
- Device power supply from measuring input or separate connection Overvoltage protection (SPD) as an option
- Communication via mobile network as an option
- Comprehensive cyber security
- IP65 housing, pre-wired
- External dimensions of housing: 360 x 160 x 91 mm



Device with Rogowski current measurement

BASIC DEVICE	ADDITIONAL FEATURES	APPLICATION
SINEAX DM5000 (power flow analysis with event recording)	<ul style="list-style-type: none"> • Rogowski current measurement (L1, L2, L3, N / PEN) • Acquisition and recording of load profiles • Option PME: Wireless energy flow recording (up to 100 currents) 	<ul style="list-style-type: none"> • Energy management • Load flow monitoring • Provide grid status data
LINAX PQ5000 (power flow analysis, incl. power quality analysis)	<ul style="list-style-type: none"> • Rogowski current measurement (L1, L2, L3, N / PEN) • Acquisition and recording of load profiles • Comprehensive power quality analysis in accordance with IEC 61000-4-30 Ed. 3, Class A • Additional monitoring and recording of current, frequency, unbalance and signal voltage events • Option PME: Wireless energy flow recording (up to 100 currents) 	<ul style="list-style-type: none"> • PQ compliance verification • Comprehensive recording of PQ events • Energy management • Load flow monitoring • Provide grid status data
LINAX PQ5000CL (Power flow analysis "High Performance", incl. power quality analysis)	<ul style="list-style-type: none"> • Rogowski current measurement (L1, L2, L3, N / PEN) with Current Link modules for up to 10 measuring points • Power analysis of all measuring points • Optional communication via IEC 61850 	<ul style="list-style-type: none"> • PQ conformity check • Load flow monitoring • Provide grid status data
CENTRAX CU5000 (controller unit with measuring function for PV systems for grid-compatible operation)	<ul style="list-style-type: none"> • Rogowski current measurement (L1, L2, L3, N / PEN) • Acquisition and recording of load profiles • Option PME: Wireless energy flow recording (up to 100 currents) 	<ul style="list-style-type: none"> • Collection of measurement data from other SmartGridBoxes • Data analysis with the help of a Soft-PLC application • Control and / or regulation of processes or generation plants using the Soft-PLC application • Energy management • Load flow monitoring • Providing grid status data

MONITORING AND CONTROLLING

We offer the unique possibility of not only acquiring all variables of the electrical grid precisely and reliably, but also processing them directly via a PLC integrated into the device and controlling processes. This enables us to realise process controls directly at the measuring point. You thus save a separate PLC or you realise an autarkically working redundant solution.

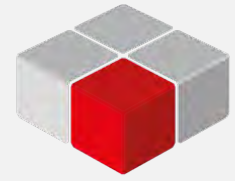

CODESYS

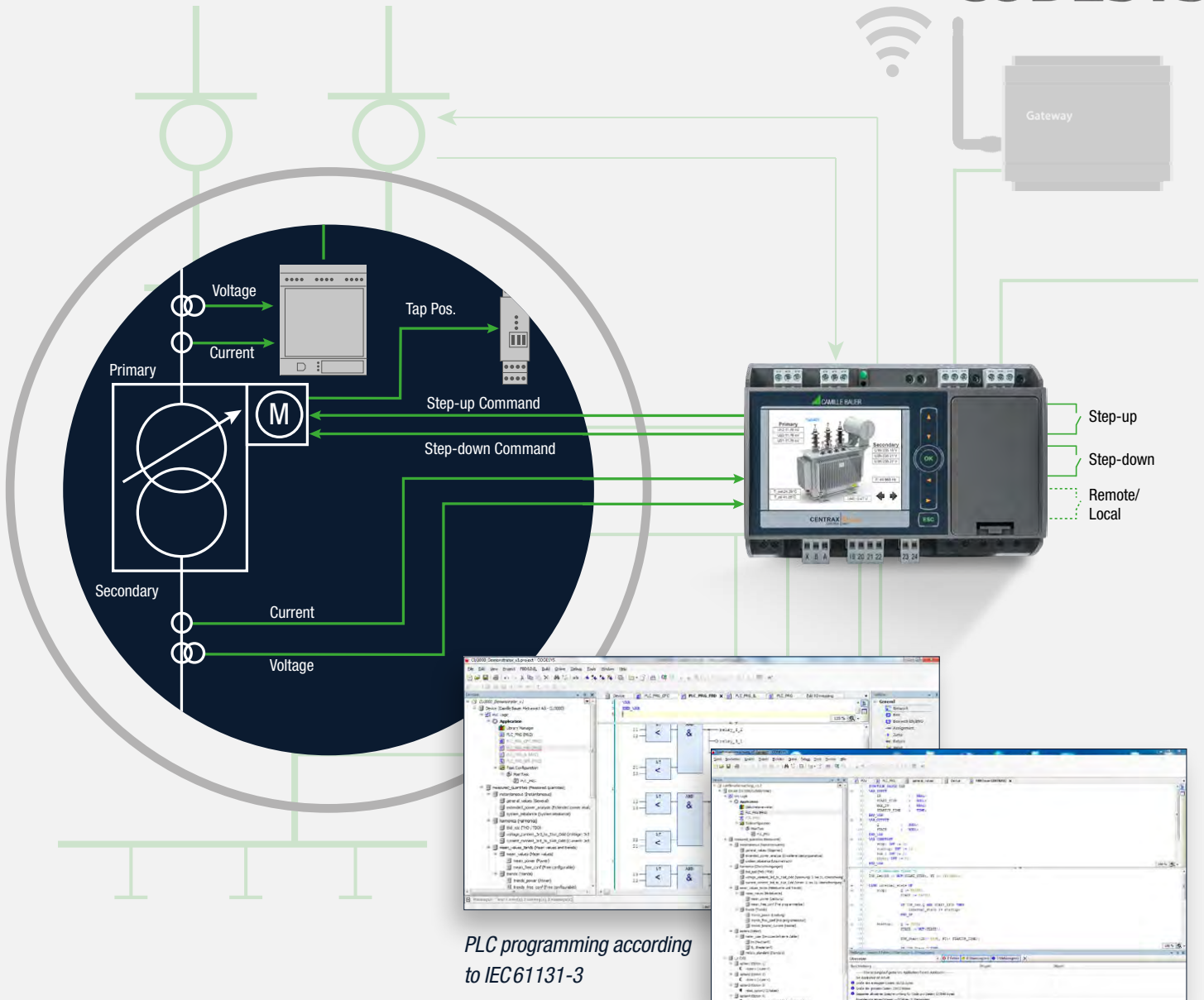

PLC programming according to IEC61131-3

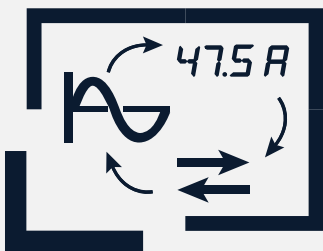

MONITORING AND CONTROLLING

- Functionality of a highly precise instrument combined with a Soft-PLC
- On-site recording and visualising of measured data
- User-specific visualising of the programmed PLC facility
- Innovative and scalable operating concepts for intuitive use of data (WebGUI)
- Integration of further devices via Modbus interface
- Measuring tasks and automation tasks derived from the same can be solved directly

SOFTWARE, SYSTEMS AND SOLUTIONS

We design modular customer-specific solutions and systems which can be extended at any time regardless of manufacturer. Through our non-proprietary interfaces is also an integration in

already existing applications and systems with components from different manufacturers no problem.

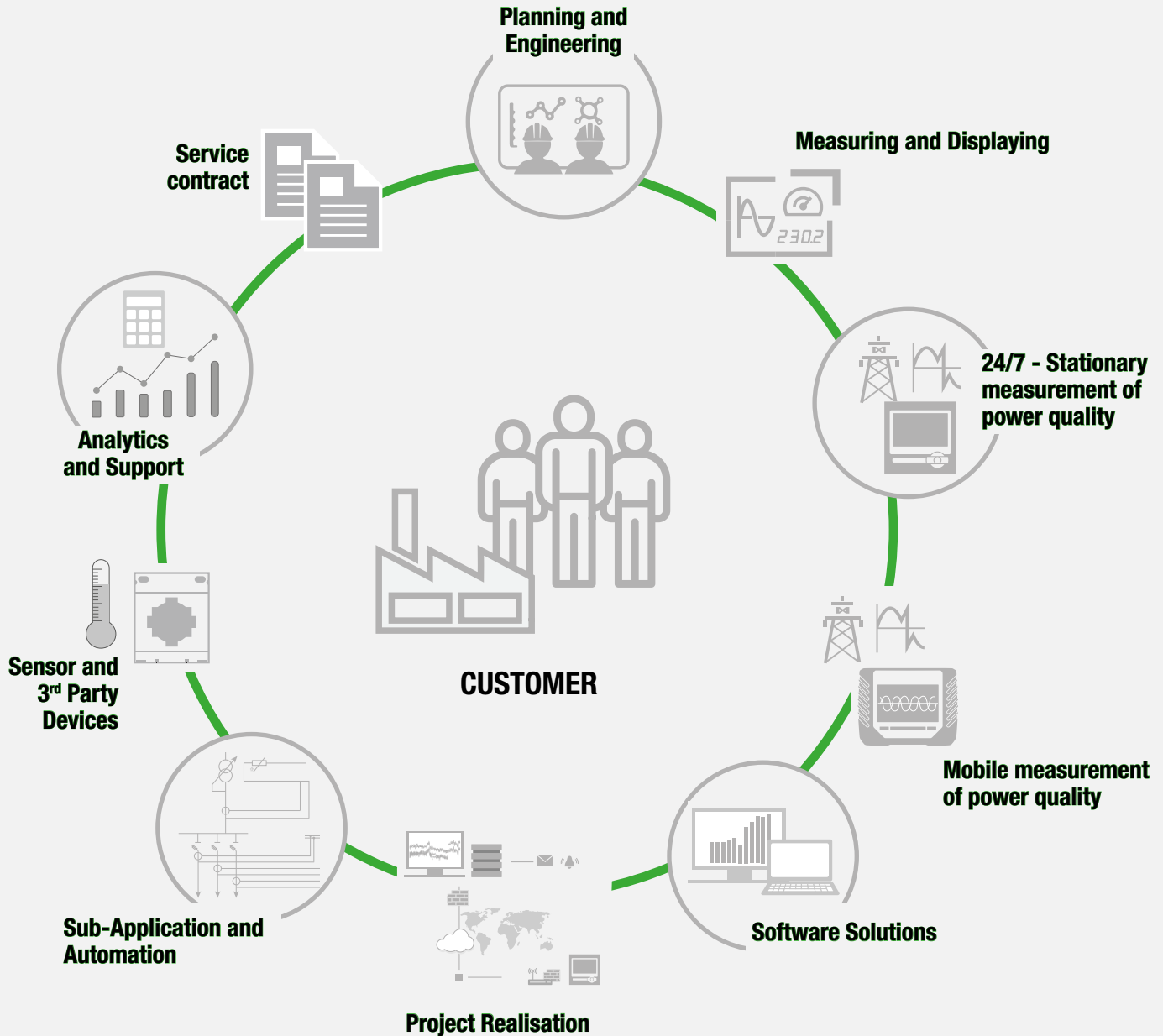

SOFTWARE, SYSTEMS AND SOLUTIONS

- Use of targeted software solutions
- Central recording and structuring of measured data of the most varied instruments
- Preparation of cost centre-related energy reports
- Extensive visualising of measured values and grid events
- Individual process visualising
- Conducting measurement campaigns
- Analysis of power quality data and fault finding



CYBER PROTECTION ON LEVEL MEASURING DEVICES

Critical infrastructures - and this undoubtedly includes the supply of electrical energy - are increasingly the target of cyber attacks. There is not only the attempt of stealing data by unauthorised access or eavesdropping of communication but also the limitation or even interruption of energy supplies by manipulating data or data traffic.

A comprehensive safety concept on plant level comprising each grid component is required to repel such attacks. The safety mechanisms integrated into LINAX® PQx000 support such concepts, thus contributing to safe energy supplies.

SAFETY MECHANISMS

- **Role-Based Access Control (RBAC):** Allows different users to be granted individual rights or to restrict them to those activities that correspond to their role. Each available menu item, whether measured value, setting value or service function, can thus be displayed, hidden, changeable or locked. As soon as the RBAC is active, even software can only access data of the device via access keys. During the login process, information is never transmitted in plain text, and the latency time is constantly increased in the event of repeated, unsuccessful login attempts.
- **Encoded data transmission via HTTPS** using root certificates
- **Audit log:** Logging of all activities relevant to safety. Transfer option to central grid monitoring server by Syslog.
- **Client white list:** Limitation of computers with access authorisation
- **Digitally signed firmware files** for secure updates
- **Data logger & Uninterruptible Power Supply (UPS)**
 - SD card memory
 - 16 GB data memory lasts for many years in typical operation
 - UPS with 5×3 minutes in case of power failure on the supply
- **Data export**
 - Manual data export via CSV & PQDIF
 - Automated data export csv & PQDIF (scheduler)
 - Event push (PQDIF) to the SFTP server
- **Secure connection via gateway**
 - VPN Cloud-Service
 - Mobile phone connection

• Metrologically certified measuring system

- METAS Certificate (Swiss Federal Institute of Metrology)
- Certified power quality according to IEC61000-4-30 Ed.3, Class A & S
- Zertifizierte Wirkenergie nach Klasse 0.2S

• Non-µP Measurement Devices

The easiest way to implement cyber security

- Transducer for I/U/P/Q
- “Stupid” hardware prevents IT attacks (no IP address)
- High availability and durability over decades
- Global proven technology

Time	PID	Priority	IP address	User name	Message
13.01.2021, 14:38:03	cb-gui	Info	192.168.57.69:49270	admin	User logged out successfully
13.01.2021, 14:22:47	cb-gui	Notice	192.168.57.69:63931	admin	User reviewed latest security event log (allow)
13.01.2021, 14:22:32	cb-gui	Notice	192.168.57.69:63933	admin	User logged in successfully
13.01.2021, 14:20:28	cb-gui	Notice	192.168.57.69:63790	anonymous	User reviewed latest security event log (allow)
13.01.2021, 14:07:51	cb-gui	Info	195.49.116.212:62261	admin	User has been logged out due to inactivity
13.01.2021, 13:47:31	cb-gui	Notice	195.49.116.212:60235	admin	User reviewed latest security event log (allow)
13.01.2021, 13:33:11	cb-gui	Notice	195.49.116.212:60196	admin	User logged in successfully
07.01.2021, 11:51:09	cb-gui	Warning	46.126.246.147:1436	admin	Failed login attempt# 3
07.01.2021, 11:49:39	cb-gui	Warning	46.126.246.147:1417	admin	Failed login attempt# 2
07.01.2021, 11:48:30	cb-gui	Warning	46.126.246.147:1419	admin	Failed login attempt# 1
29.12.2020, 10:49:27	cb-gui	Notice	223.186.41.211:5122	anonymous	User reviewed latest security event log (allow)

Audit log with filter option

	admin	localgui	anonymous	Operator1	Operator2	Operator3	[API]AccessKey
Local account (no weblgin)	<input type="checkbox"/>	<input checked="" type="checkbox"/>	<input type="checkbox"/>	<input type="checkbox"/>	<input type="checkbox"/>	<input type="checkbox"/>	<input type="checkbox"/>
Instantaneous values	<input checked="" type="checkbox"/>	<input checked="" type="checkbox"/>	<input checked="" type="checkbox"/>	<input checked="" type="checkbox"/>	<input checked="" type="checkbox"/>	<input checked="" type="checkbox"/>	<input checked="" type="checkbox"/>
Energy	<input checked="" type="checkbox"/>	<input checked="" type="checkbox"/>	<input checked="" type="checkbox"/>	<input checked="" type="checkbox"/>	<input checked="" type="checkbox"/>	<input checked="" type="checkbox"/>	<input checked="" type="checkbox"/>
Harmonics	<input checked="" type="checkbox"/>	<input checked="" type="checkbox"/>	<input checked="" type="checkbox"/>	<input checked="" type="checkbox"/>	<input checked="" type="checkbox"/>	<input checked="" type="checkbox"/>	<input checked="" type="checkbox"/>
Phasor diagram	<input checked="" type="checkbox"/>	<input checked="" type="checkbox"/>	<input checked="" type="checkbox"/>	<input checked="" type="checkbox"/>	<input checked="" type="checkbox"/>	<input checked="" type="checkbox"/>	<input checked="" type="checkbox"/>
Waveform	<input checked="" type="checkbox"/>	<input checked="" type="checkbox"/>	<input checked="" type="checkbox"/>	<input checked="" type="checkbox"/>	<input checked="" type="checkbox"/>	<input checked="" type="checkbox"/>	<input checked="" type="checkbox"/>
Events	<input checked="" type="checkbox"/>	<input checked="" type="checkbox"/>	<input checked="" type="checkbox"/>	<input checked="" type="checkbox"/>	<input checked="" type="checkbox"/>	<input checked="" type="checkbox"/>	<input checked="" type="checkbox"/>
PQ statistic	<input checked="" type="checkbox"/>	<input checked="" type="checkbox"/>	<input checked="" type="checkbox"/>	<input checked="" type="checkbox"/>	<input checked="" type="checkbox"/>	<input checked="" type="checkbox"/>	<input checked="" type="checkbox"/>
Service	<input checked="" type="checkbox"/>	<input checked="" type="checkbox"/>	<input checked="" type="checkbox"/>	<input checked="" type="checkbox"/>	<input checked="" type="checkbox"/>	<input checked="" type="checkbox"/>	<input checked="" type="checkbox"/>
Reset values	<input checked="" type="checkbox"/>	<input checked="" type="checkbox"/>	<input checked="" type="checkbox"/>	<input checked="" type="checkbox"/>	<input checked="" type="checkbox"/>	<input checked="" type="checkbox"/>	<input checked="" type="checkbox"/>
Reset/Update device	<input checked="" type="checkbox"/>	<input checked="" type="checkbox"/>	<input checked="" type="checkbox"/>	<input checked="" type="checkbox"/>	<input checked="" type="checkbox"/>	<input checked="" type="checkbox"/>	<input checked="" type="checkbox"/>
Audit Log	<input checked="" type="checkbox"/>	<input checked="" type="checkbox"/>	<input checked="" type="checkbox"/>	<input checked="" type="checkbox"/>	<input checked="" type="checkbox"/>	<input checked="" type="checkbox"/>	<input checked="" type="checkbox"/>
Use IO simulation	<input checked="" type="checkbox"/>	<input checked="" type="checkbox"/>	<input checked="" type="checkbox"/>	<input checked="" type="checkbox"/>	<input checked="" type="checkbox"/>	<input checked="" type="checkbox"/>	<input checked="" type="checkbox"/>
Settings	<input checked="" type="checkbox"/>	<input checked="" type="checkbox"/>	<input checked="" type="checkbox"/>	<input checked="" type="checkbox"/>	<input checked="" type="checkbox"/>	<input checked="" type="checkbox"/>	<input checked="" type="checkbox"/>
Basic device settings	<input checked="" type="checkbox"/>	<input checked="" type="checkbox"/>	<input checked="" type="checkbox"/>	<input checked="" type="checkbox"/>	<input checked="" type="checkbox"/>	<input checked="" type="checkbox"/>	<input checked="" type="checkbox"/>
Measurement	<input checked="" type="checkbox"/>	<input checked="" type="checkbox"/>	<input checked="" type="checkbox"/>	<input checked="" type="checkbox"/>	<input checked="" type="checkbox"/>	<input checked="" type="checkbox"/>	<input checked="" type="checkbox"/>
Communication	<input checked="" type="checkbox"/>	<input checked="" type="checkbox"/>	<input checked="" type="checkbox"/>	<input checked="" type="checkbox"/>	<input checked="" type="checkbox"/>	<input checked="" type="checkbox"/>	<input checked="" type="checkbox"/>
Security system	<input checked="" type="checkbox"/>	<input checked="" type="checkbox"/>	<input checked="" type="checkbox"/>	<input checked="" type="checkbox"/>	<input checked="" type="checkbox"/>	<input checked="" type="checkbox"/>	<input checked="" type="checkbox"/>

RBAC access rights of different users



SMARTCOLLECT® SC²



Building management system and enterprise applications

Upstream

- Modbus/TCP
- OPC UA
- BACnet
- SNMP
- DNP3
- IEC61850 MMS
- RESTful API
- DDE
- etc.



Multiple users

SMARTCOLLECT SC²

Downstream

- Modbus/TCP
- Modbus/RTU
- etc.

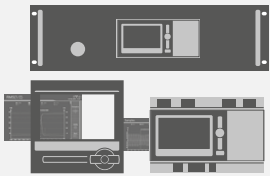

Cyber secure Camille Bauer devices

Third-party devices



Gas meter



Energy meter



Flow



Temperature



Water meter

Features



Open platform



Web-based and secure including RBAC



Native cloud support

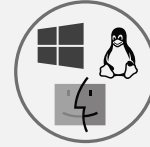

Operating system agnostic (Windows, Linux, MacOS)



To see the benefits for yourself, visit our live page:

www.scada-smartcollect.com



PQ-VIEW®

INTELLIGENT, WEB-BASED SOFTWARE FOR PROFESSIONAL POWER QUALITY ANALYSIS

- Web-based access
- Works as system controller and user surface
- Automated communication with connected devices via supported communication methods
- Integration of power quality devices from other manufacturers
- Application from small systems through to large multipoint, plant and supply monitoring
- Data like trends, real-time views and reports can be easily exchanged and checked, e.g. Word, Excel
- Client-, Server architecture (database)

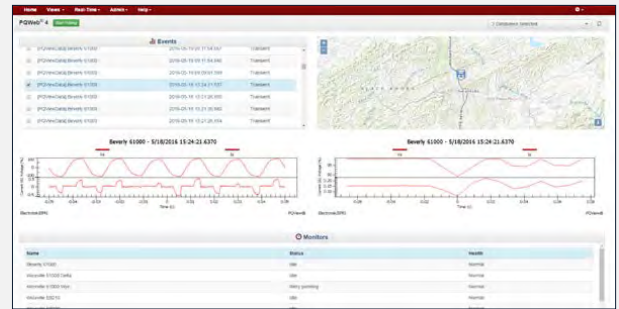
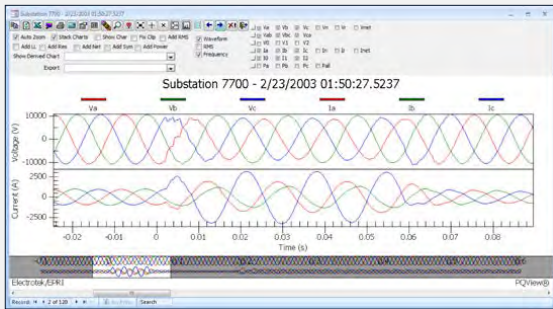

METRAVIEW

THE PLATFORM FOR YOUR ENERGY DATA

METRAVIEW takes software-supported data acquisition, analysis and visualization of energy and heavy current values to a new level.

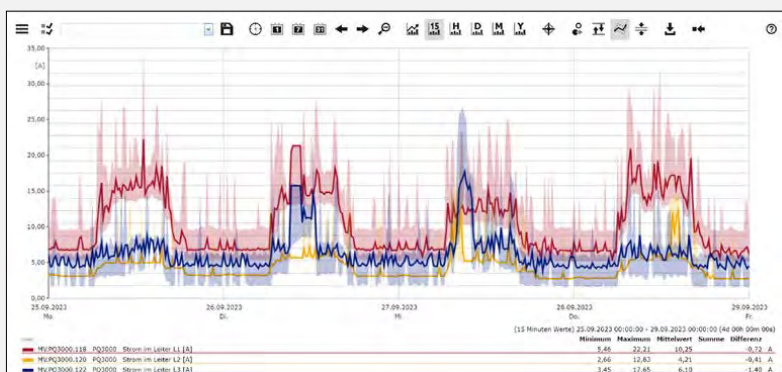
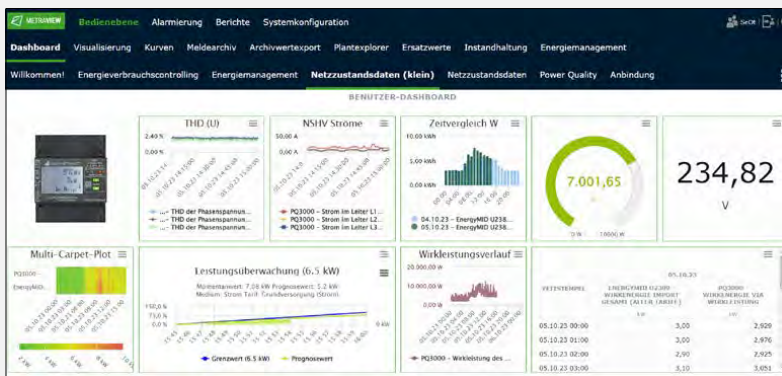



STABLE MEASUREMENT WITH RADIO TECHNOLOGY

If the extremely high technical performance of hard-wired Current Link technology can be dispensed with in the smart grid application, a scalable solution via radio is also possible. The radio solution has wireless sensors - the so-called PME modules (Power Monitoring Energy), which transmit wirelessly to the PME base station. A major advantage is that up to 100 currents (individual conductors) can be measured per base station. In

addition, 5 PME systems can be operated at the same location. The PME base station consists of a standard device of the SINEAX® AM, SINEAX® DM, LINAX® PQ or CENTRAX® CU series with a corresponding additional option. This solution is not only extremely space-saving and efficient, but also good for the budget.

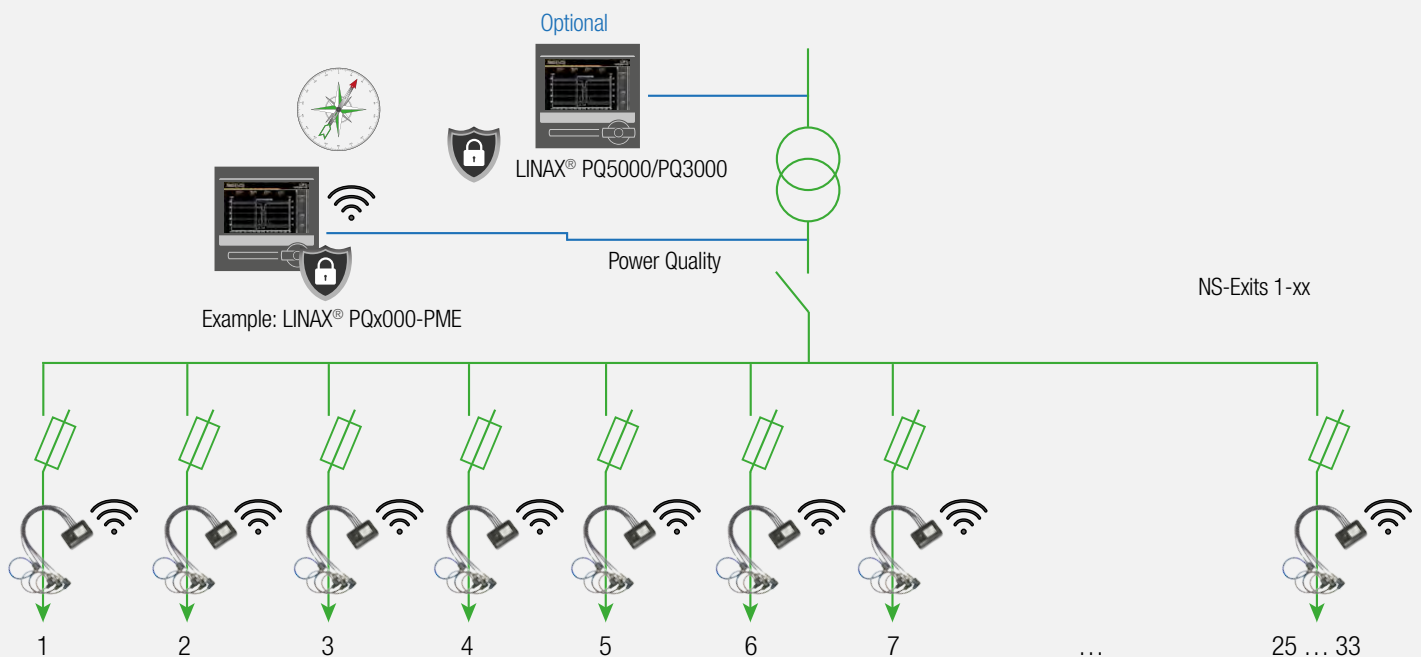

Base station with SINEAX® AM, SINEAX® DM, LINAX® PQ or CENTRAX® CU series, incl. integrated Power Monitoring Energy Module (PME) and PME sensors for acquisition of max. 100 currents via radio signal.

PME system

- Efficient base station from the standard SINEAX® AM, SINEAX® DM, LINAX® PQ and CENTRAX® CU series.
- PME sensors with Rogowski coils and configurable ranges (250 A, 500 A or 1000 A)
- Sensor and PME central unit have a UUID (Universally Unique Identifier) derived from the Bluetooth address of the radio module
- Secure protocol for communication between current sensors and central unit (Advanced Encryption Standard AES-128, standard for WLAN communication)
- 3P or 3PN by means of PME per feeder (max. 100 currents)
- Very fast roll-out due to easy sensor registration via QR code
- Power supply via battery (runtime up to 10 years) or USB-C
- Anti-collision detection allows up to 5 PME systems at the same location
- Channel monitoring ensures that no frequency channel is used that is already occupied by another device (e.g. Bluetooth or WLAN device)
- Access to sensor data via Modbus RTU or TCP/IP, REST API, CSV export
- Sampling rate 6kHz of the sensors
- ...and even more features that we can take over from the Current-Link technology

SMART GRID COMPLETE SOLUTION

Particularly in the low-voltage distribution network, where the supply and withdrawal of energy is subject to major changes, measures for more active network control and forward-looking network management are becoming necessary.

In connection with the digitalization of local network stations, Camille Bauer and its cooperation partners offer secure solutions for more network transparency. This is based on well-founded and market-tested hardware and software components.

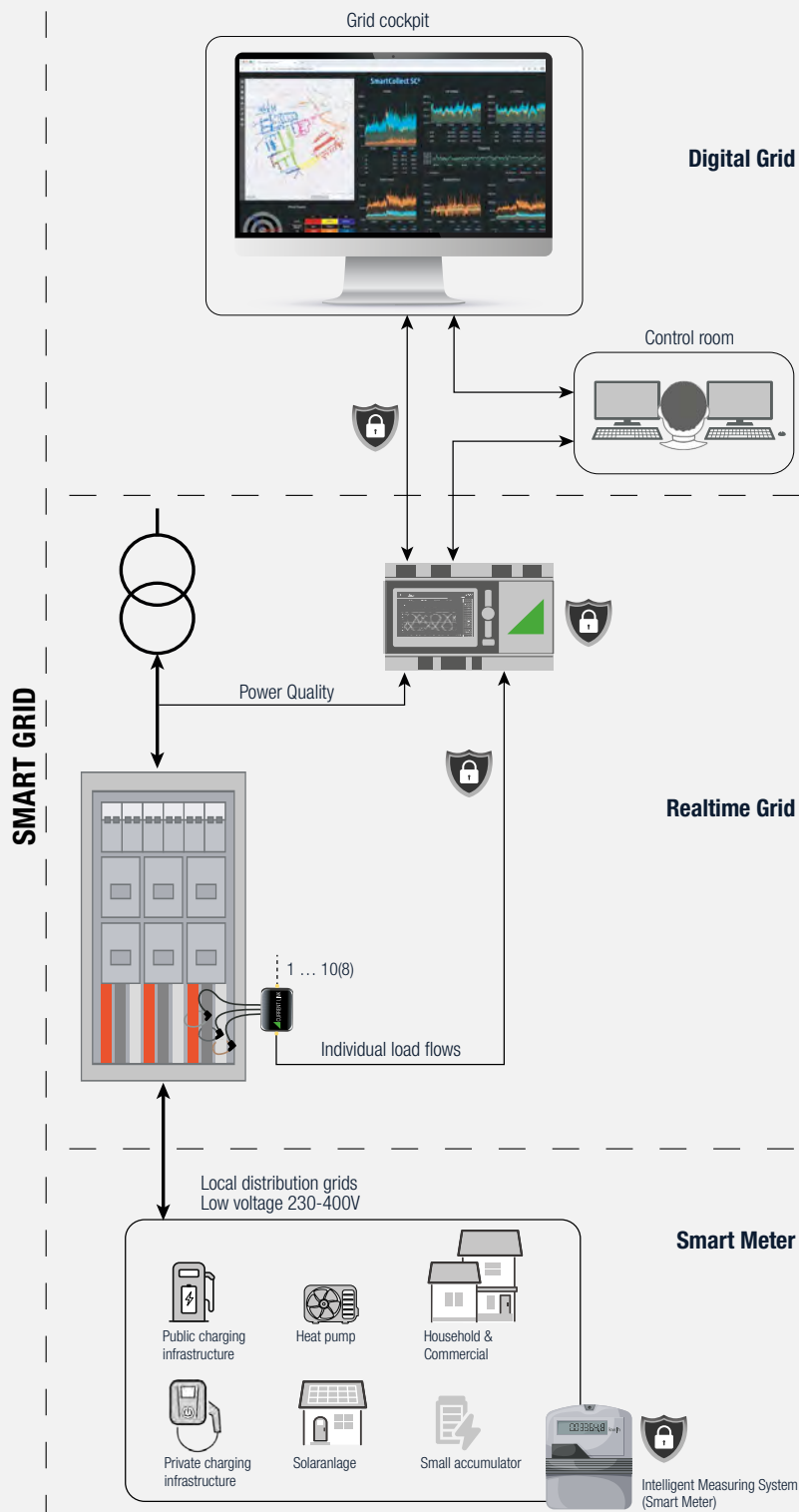

INFORMATIVE WEBSITE ON THE SUBJECT OF POWER QUALITY

Bringing more light into the dark

For the stakeholders, whether already familiar with the topic of power quality today or not, the website on the topic of power quality aims to provide useful information from theory and practice. And this is exactly what the name «Power Quality as a Service», already known in software services, is intended to emphasize with it. The website provides knowledge about relevant standards, measurement methods,

why and where power quality is actually an issue, what are the phenomena and how do they manifest themselves, what to look out for, how to ensure good power quality, application examples, term hygiene, FAQ, etc.

The website sees itself as a cooperation platform

In order to do justice to the topic of power quality in its various facets, Power Quality as a Service, or PQaaS for short, is based on standards, guidelines and experience. Thus, the PQaaS is not a stand-alone production, but rather combines international knowledge and technologies from the most diverse areas on the topic of power quality. In doing so, the PQaaS tries to keep itself up to date and interesting and thus actively

participates in the social media scene. The inclusion for the provision of content contributions is thereby desired. Blog contributions as well as interactive chats support this. Not least also, in order to develop the partner network of the PQaaS further and to create trusting use for all interested ones.

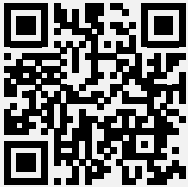

<https://pq-as-a-service.com>

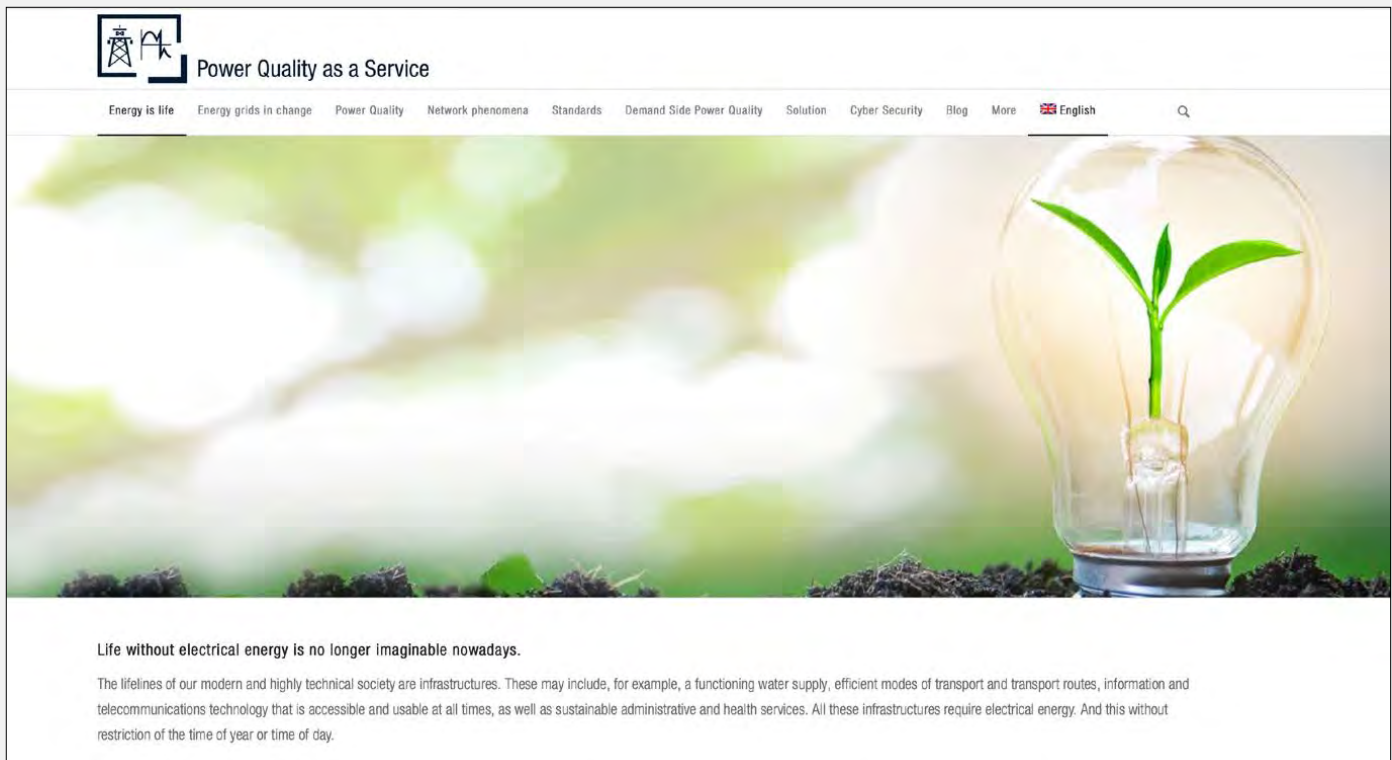

CAMILLE BAUER METRAWATT ACADEMY

The Camille Bauer Metrawatt stands as a traditional Swiss company, for a high degree of quality, reliability and expertise. In many inspiring seminars, we offer a platform to participate in our knowledge and that of many external experts.

Our goal is to provide all those interested with the necessary expertise in the field of electrical energy and thus make processes more efficient, to protect the environment and to protect man and machine.



Each of our seminars offers you:

- A platform for maintaining your personal network
- The opportunity to ask questions at any time and get to know the speakers in person
- Catering at day seminars
- An on-site calibration service for your measurement devices
- A certificate of participation as proof of your further education

A STRONG BRAND WORLD

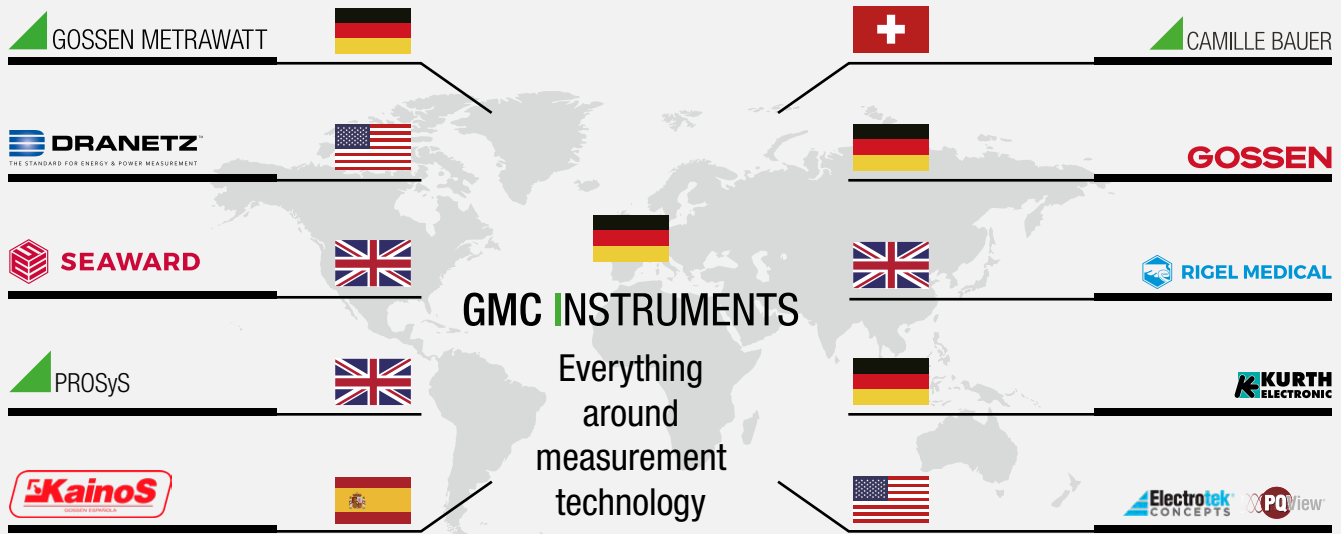

We design safety, worldwide and with specialists in the respective core segments - the GMC Instruments Group.

A strong brand world stands with Gossen Metrawatt GmbH, Camille Bauer, Dranetz Technologies Inc., GMC-I PROSYS Ltd., GOSSEN Foto- & Lichtmesstechnik GmbH as well as Seaward Electronic Ltd., Electrotek Concepts Inc. and Rigel Medical for highest quality and constant innovation in the field of measurement technology.

Further fields of the GMC-Instruments Group:

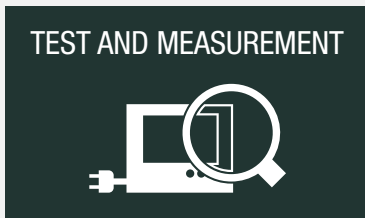

TEST AND MEASUREMENT

Being a leading provider of measuring and testing technology, we offer our customers a wide and modern portfolio of instruments. High-quality multimeters, device testers, installation test devices as well as an extensive service program – this is what Gossen Metrawatt stands for.



Secutest

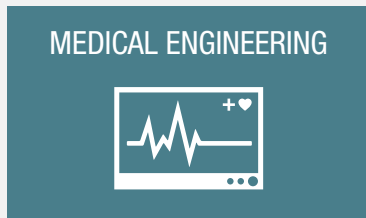

MEDICAL ENGINEERING

More than 100 years of experience in measuring and testing technology combined with state-of-the-art standards guarantee the highest degree of quality and reliability in sensitive areas. Our medical engineering instruments ensure the correct and safe operation of often vital equipment.



Seculife Hit



PHOTOGRAPHY AND LIGHT MEASURING

Gossen Foto- und Lichtmesstechnik GmbH is specialised in light measurement and has decades of experience in this field. The portfolio comprises instruments to determine illumination intensity and light density and to monitor interior light.



Mavolux

OUR SEGMENTS

Health



Health is - not only proverbially - one of man's greatest assets. We associate health with positive things such as fitness, joie de vivre and satisfaction. However, good health is also a prerequisite for coping with the numerous demands of work and private life.

Mobility



Mobility is a mega trend that primarily describes the movement of people and goods. In addition to the necessary willingness to offer mobility, a very broad range of different technologies is required.

Industrial infrastructure



Infrastructure is the heart of a modern society. Sustainability goals are inconceivable without intelligent innovations, modern infrastructures and an efficient industry.

Fields of application for energy measurement technology

Exemplary example for measuring device application [PMD, PQI, ...]

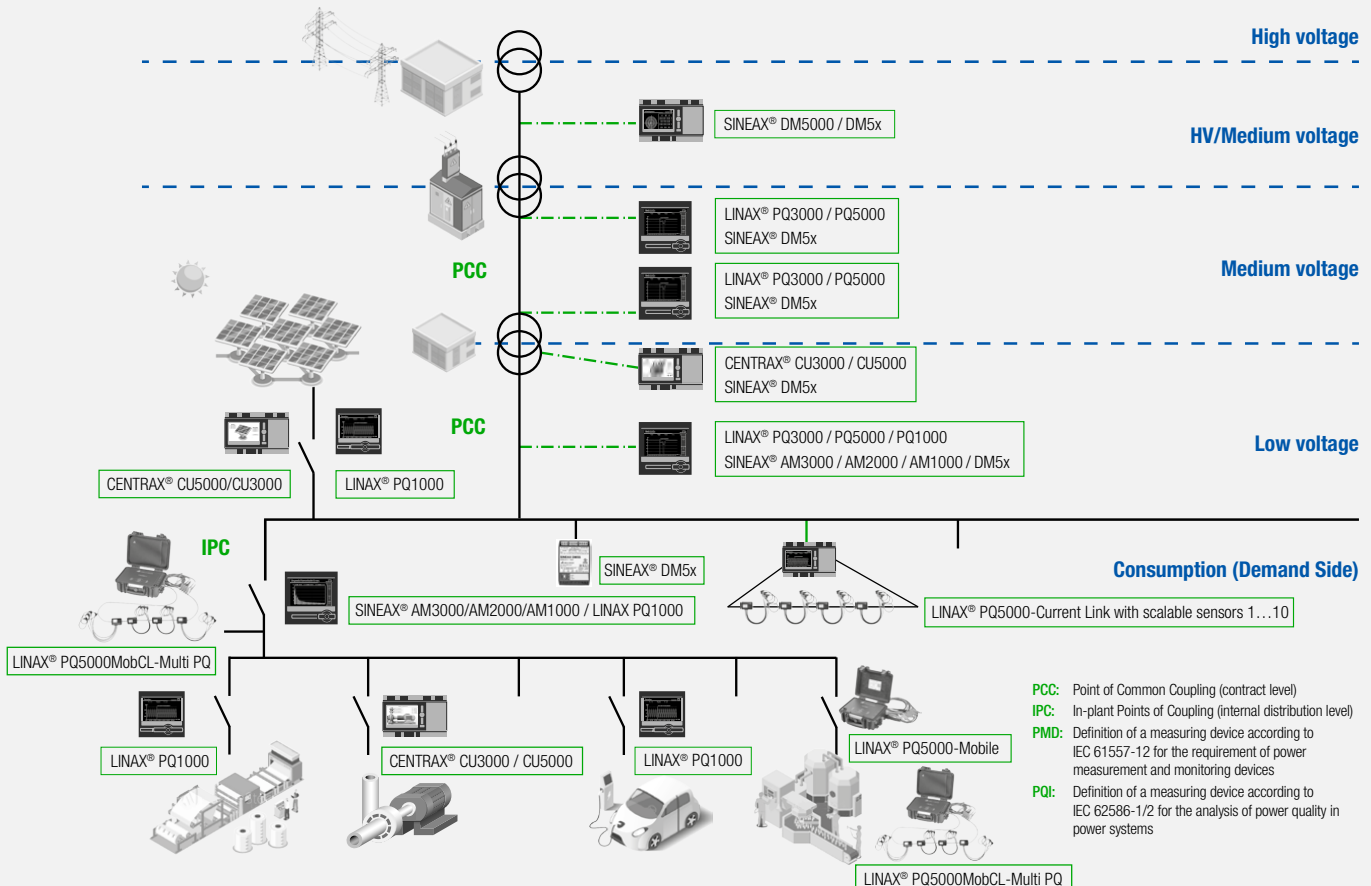



DISTRIBUTION PARTNERS IN OVER 40 COUNTRIES

GMC-I Messtechnik GmbH

Südwestpark 15
D-90449 Nürnberg
TEL +49 911 8602-111 · FAX +49 911 8602-777
www.gossenmetrawatt.com · info@gossenmetrawatt.com

Electromediciones Kainos S.A.U.

Paseo de los Ferrocarriles Catalanes · 97-117 Planta 1ª
Local 2 · E-08940 Cornellá de Llobregat · Barcelona
TEL +34 934 742 333 · FAX +34 934 743 447
www.kainos.es · kainos@kainos.es

GMC-Instruments Italia S.r.l.

Via Romagna, 4
I-20853 Biassono (MB)
TEL +39 039 2480 51 · FAX +39 039 2480 588
www.gmc-instruments.it · info@gmc-i.it

GMC-Instruments Nederland B.V.

Daggeldersweg 18
NL-3449 JD Woerden
TEL +31 348 42 11 55 · FAX +31 348 42 25 28
www.gmc-instruments.nl · info@gmc-instruments.nl

GMC-Instruments France SAS

3 rue René Cassin
F-91349 Massy Cedex
TEL +33 1 6920 8949 · FAX +33 1 6920 5492
www.gmc-instruments.fr · info@gmc-instruments.fr

GMC-měřicí technika s.r.o.

Fügnerova 1a
CZ-67801 Blansko
TEL +420 516 482 611/-617 · FAX +420 516 410 907
www.gmc.cz · gmc@gmc.cz

GMC-Instruments Austria GmbH

Richard-Strauss-Str. 10 / 2
A-1230 Wien
TEL +43 1 890 2287 · FAX +43 1 890 2287 99
www.gmc-instruments.co.at · office@gmc-instruments.co.at

GMC-Instruments (Tianjin) Co., Ltd

Rm.710 · Jin Ji Ye BLD. No.2 · Sheng Gu Zhong Rd.
P.C.: 100022 · Chao Yang District
TEL +86 10 84798255 · FAX +86 10 84799133
www.gmci-china.cn · info@gmci-china.cn

YOUR DISTRIBUTION PARTNER

Camille Bauer Metrawatt AG

Aargauerstrasse 7 · 5610 Wohlen · Switzerland
TEL +41 56 618 21 11

www.camillebauer.com · sales@camillebauer.com